

# Lecture 4: Physiological Sensor Data

CSCI6410/EPAH6410/CSCI4148

Finlay Maguire (finlay.maguire@dal.ca)

# Learning Overview

- Types of medical sensor data
- Time-domain approaches: detrending/regression models
- Alternative decomposition: frequency/time-frequency
- State-space approaches: hidden markov models
- Handling data from multiple sensors
- General purpose Bayesian approaches: Gaussian Processes
- Cough-detection example
- Segmentation of heartbeats example
- Seizure prediction example

# Physiological sensors (typically) capture data over time

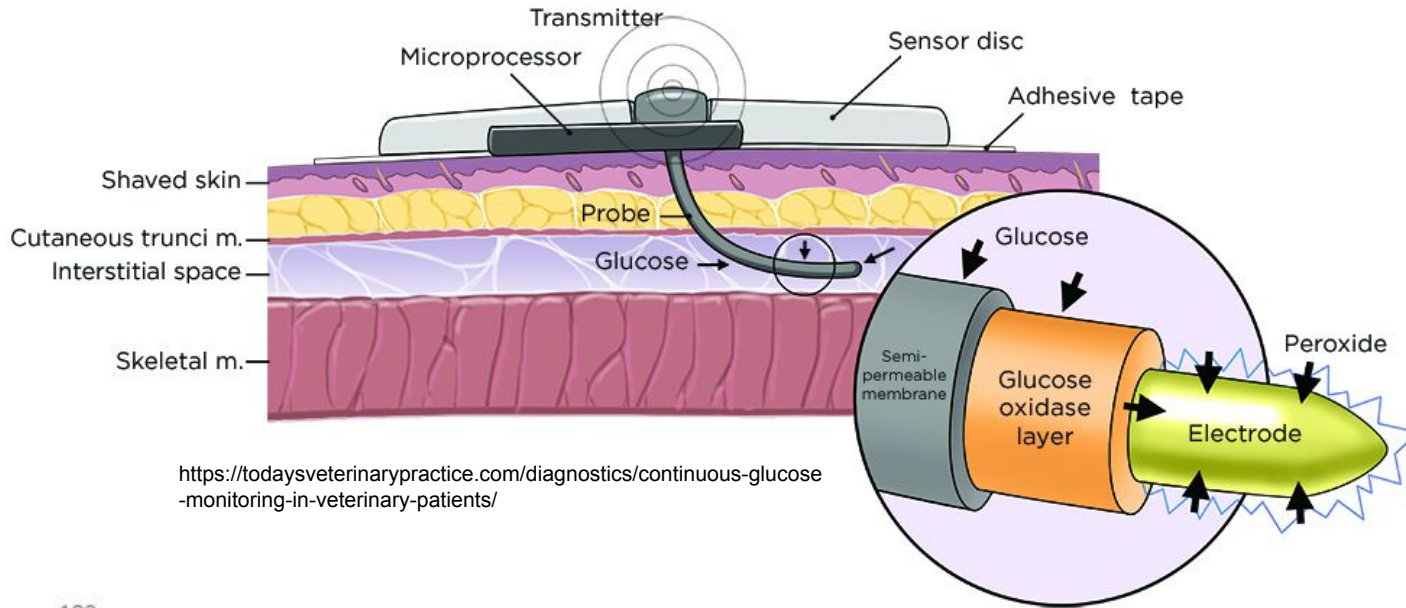

<https://todaysveterinarypractice.com/diagnostics/continuous-glucose-monitoring-in-veterinary-patients/>

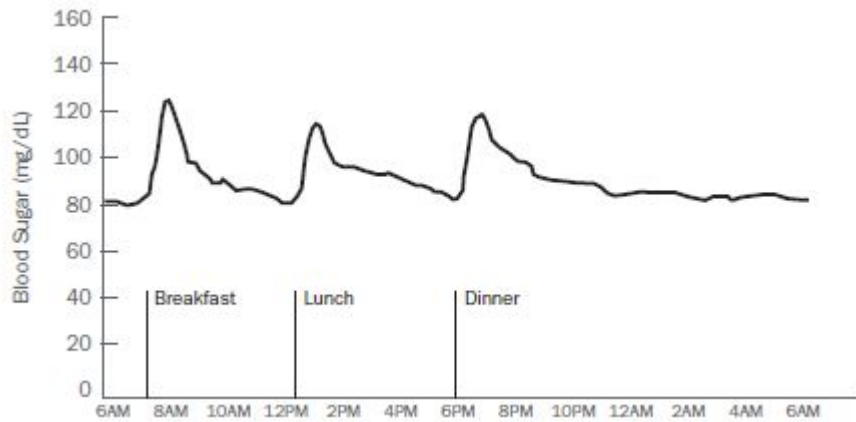

<https://www.diabetesdaily.com/learn-about-diabetes/understanding-blood-sugars/is-my-blood-sugar-normal/>

- Time-series: set of values ordered by time
- Single object observed over time vs cross-section of multiple objects on common time axis
- Simple 1-dimensional variable: continuous glucose monitoring

# Time-series often have multiple components

- Short period fluctuations: seasonality
- Long period fluctuations: cycles
- Long-term directionality: trend
- Noise: stochasticity
- Correlation in successive times: autocorrelation
- Distribution changes over time: stationarity/non-stationarity

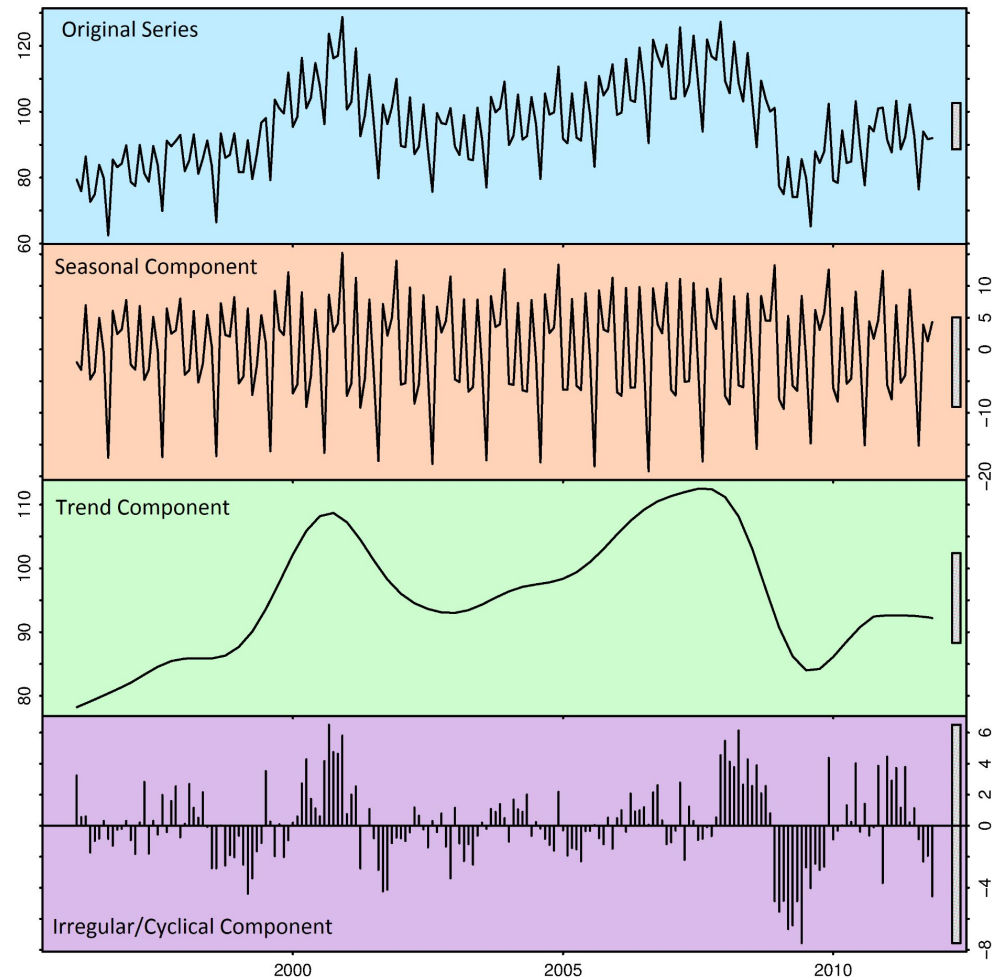

# Time can be a discrete or continuous value

- Continuous time: defined at every real value of  $T$
- Discrete time: defined at discrete intervals of  $T$
- Real-world data is continuous but sampled during collection as discrete data (sampling rate)
- Conversion to some fidelity is possible
- Impacts analysis methods

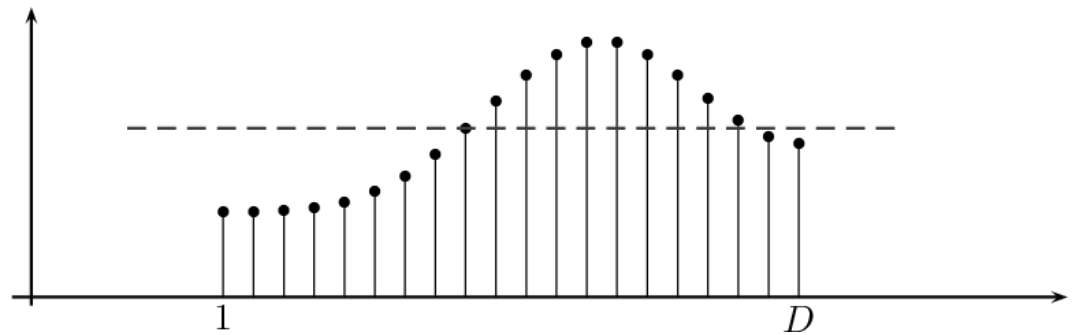
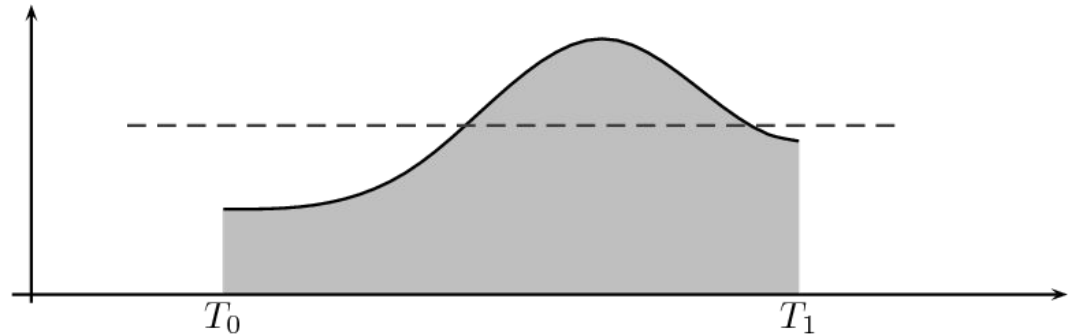

# Physiological sensors capture signal data

- “Signal” is a broadly defined term
- For today: signals are analogue or digital representations of analogue physical quantities.
- Typically electrical representations created by a transducer
- Data encoded in voltage, current and/or frequency
- Medicine: often directly capturing bioelectrical signals



<https://mynewmicrophone.com/how-do-microphones-work-a-helpful-illustrated-guide/>

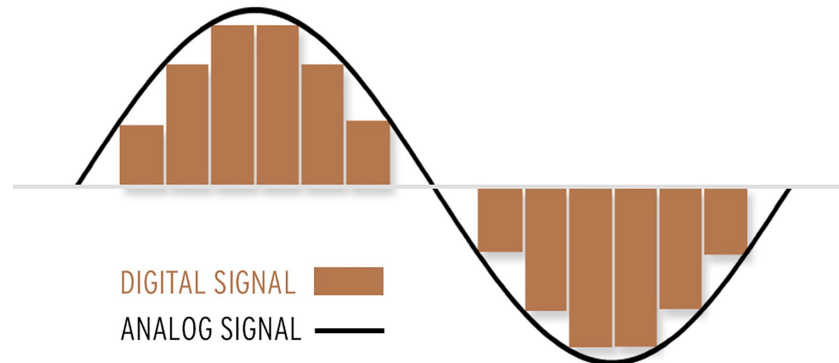

<https://www.klipsch.ca/blog/digital-vs-analog-audio>

# Electrocardiogram (ECG): cardiac electrical signals

- Recording of heart's electrical activity using multiple electrodes
- Signal from cardiac muscle {de,}polarisation during systole (contraction) and diastole (relaxation).
- Changes in pattern indicate abnormalities (e.g., rhythm disturbances, coronary blood flow, electrolyte disturbances)
- **Heart Rate**: number of cycles within period (bpm)
- **Inter-Beat Interval**: time between cycles (ms)
- **Heart Rate Variability**: variation in IBI

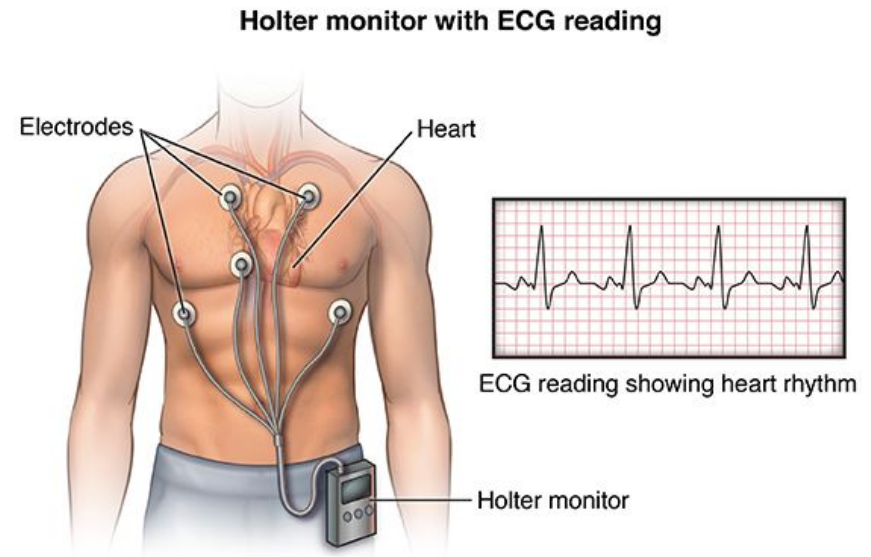

<https://www.hopkinsmedicine.org/health/treatment-tests-and-therapies/holter-monitor>

# Electrocardiogram (ECG): inscrutable defined components

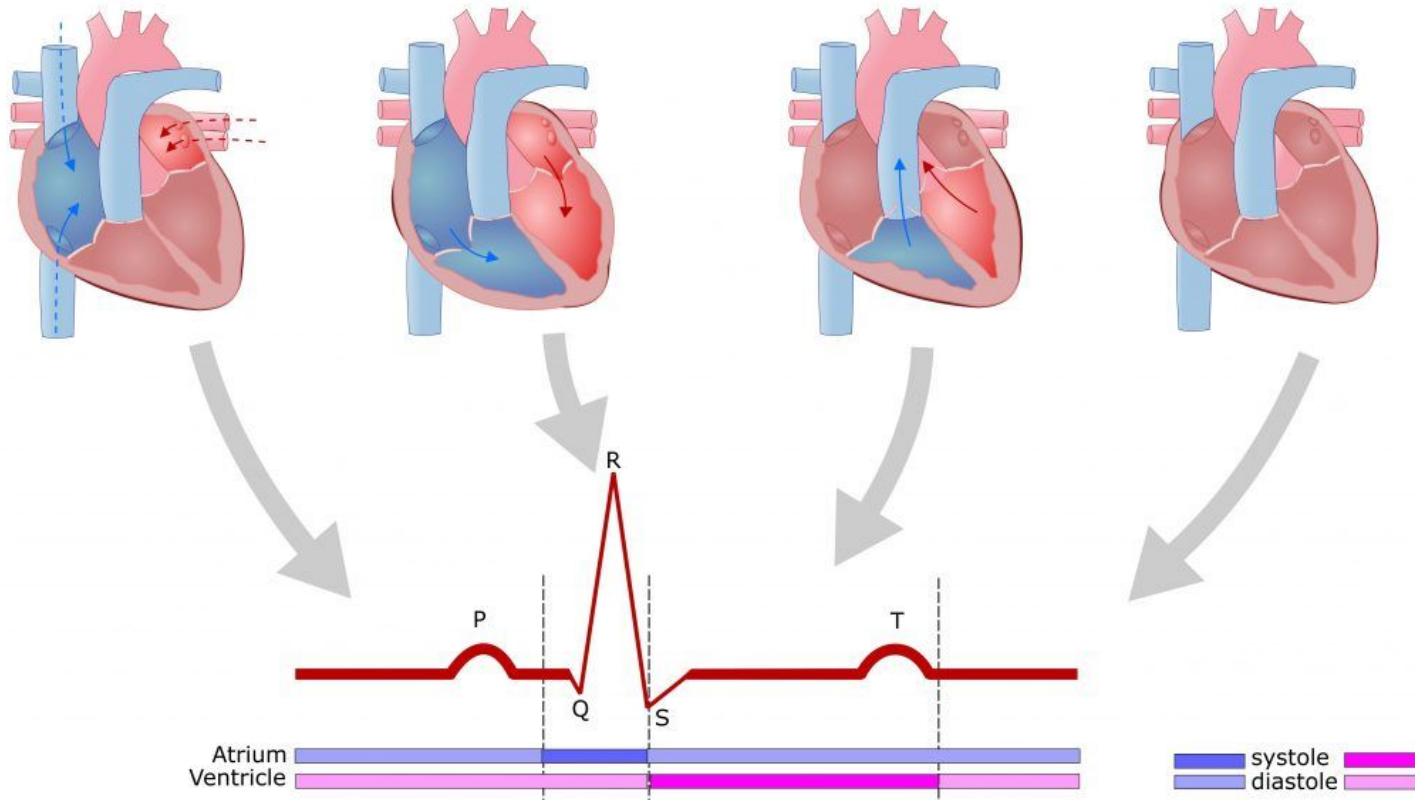

**P-wave:** depolarisation of atria -> atrial systole

**PR-interval**

**QRS complex:** atrial diastole -> depolarisation of ventricles -> ventricular systole

**ST segment**

**T-wave:** repolarization of ventricles -> ventricular diastole

**TP segment**



# Multiple sensors recording same signal improves data

- By capturing a signal from multiple sensors we get a lot more information
- 12-lead ECGs given spatial resolution on cardiac abnormalities
- Increases analytical complexity (e.g., handling inter-channel covariance + autocorrelation)

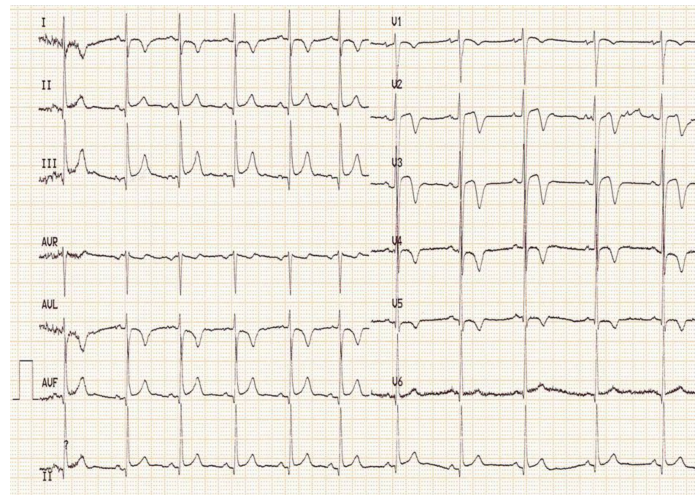
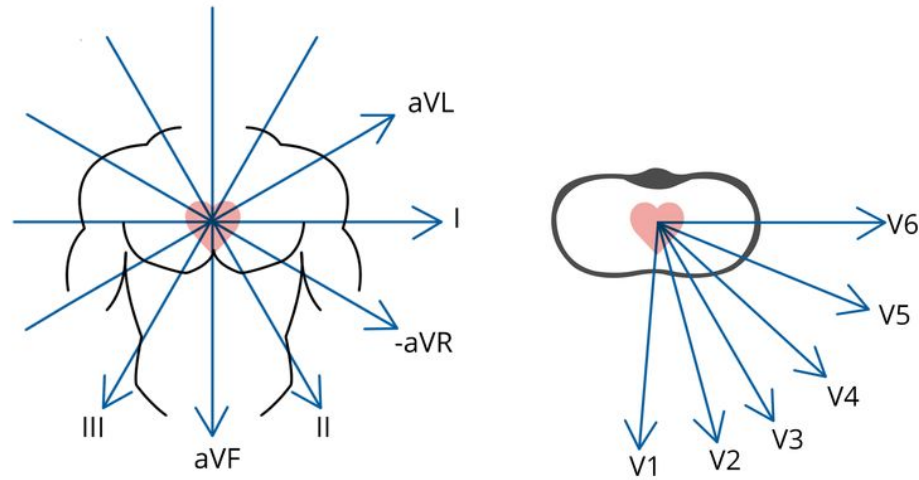

Schreibgeschwindigkeit 25mm/sec

# Electroencephalogram (EEG): many channels

- Electrogram of macroscopic brain activity measured from scalp (or intracranially).
- Signal from sets of neuron action potentials (ion-gated membrane de/repolarisation)
- Different electrode layouts/types impact signal resolution

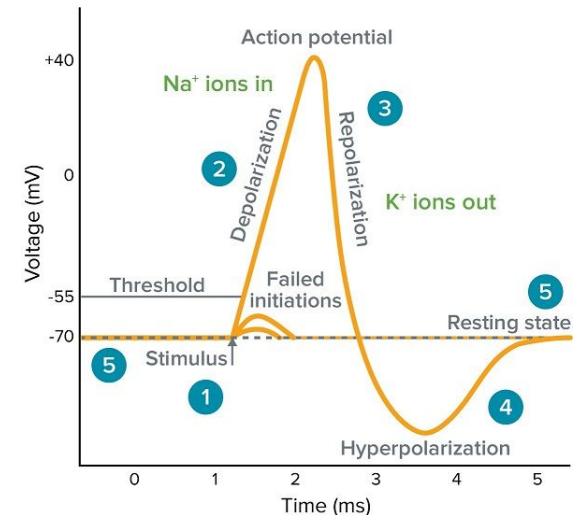
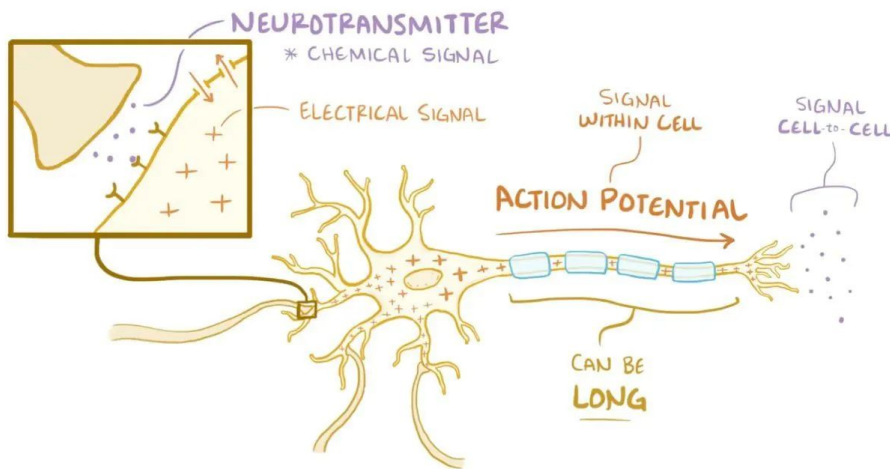
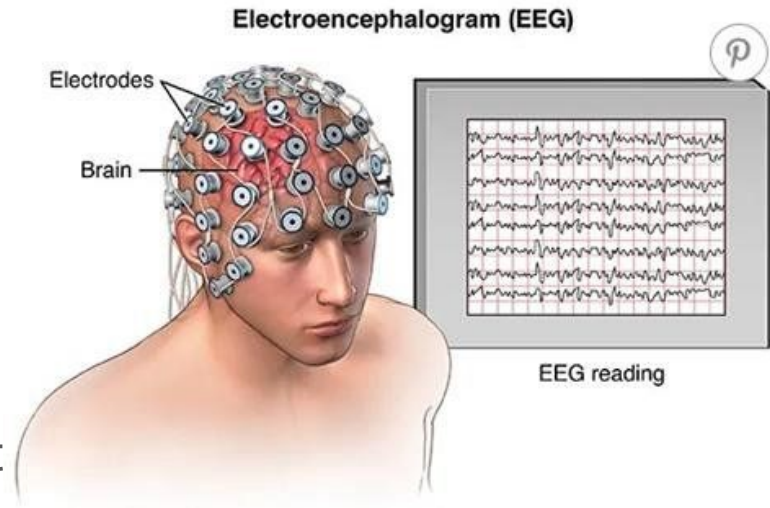

# Electroencephalogram (EEG): defined frequency bands

- EEG signals get divided into defined frequency bands
- Different brain activity typified by band of majority of activity (e.g., Delta -> Deep Sleep).
- Patterns in EEG can diagnose neurological disorders (including sleep disorders and epilepsy)

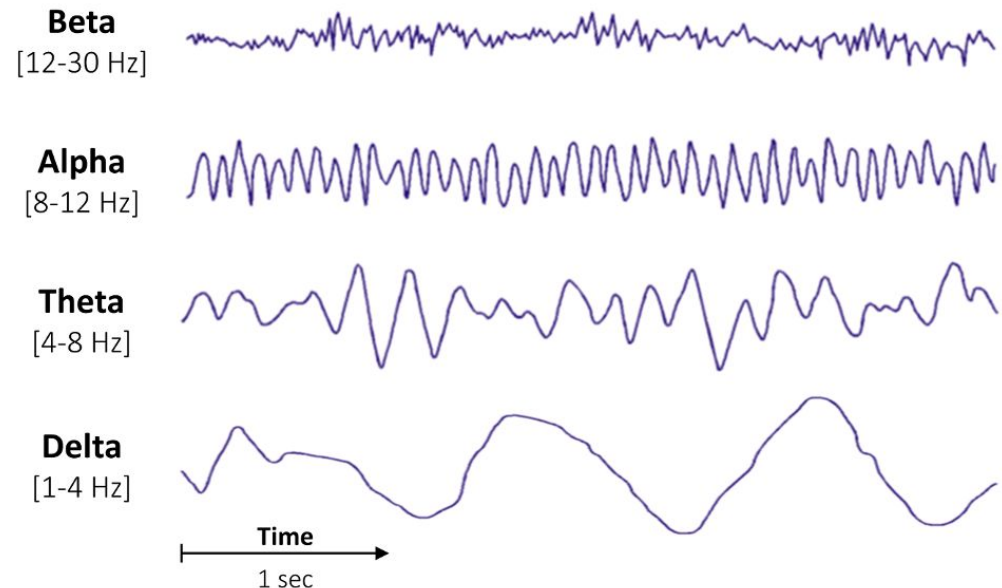

How do we analyse sensor data?

# Approaches for sensor data

- Moment (time domain) representation
  - Considering the statistical properties of the input data jointly over time
- Spectral (frequency domain) representation
  - Analysing the frequency-space representation
- Path (state space) representation
  - Describe the system as a dynamic system over time
- Change representation: systems of differential equations
  - Not going to discuss these but very common classical statistic/applied maths approach to sensor data.
  - Stochastic (SDEs) or deterministic (ODEs)

# Time Domain: Decomposition

- Decomposition enables measuring strength of trend and seasonality
- Estimate trend/cycle using moving average
- Moving average: smooth series using average over window (size = order)
- Detrend series: signal - moving average
- Moving average of detrended data: seasonality
- Multiplicative decomposition (divide rather than subtract)
- More advanced modern decomposition methods (STL/SEATS/X11)

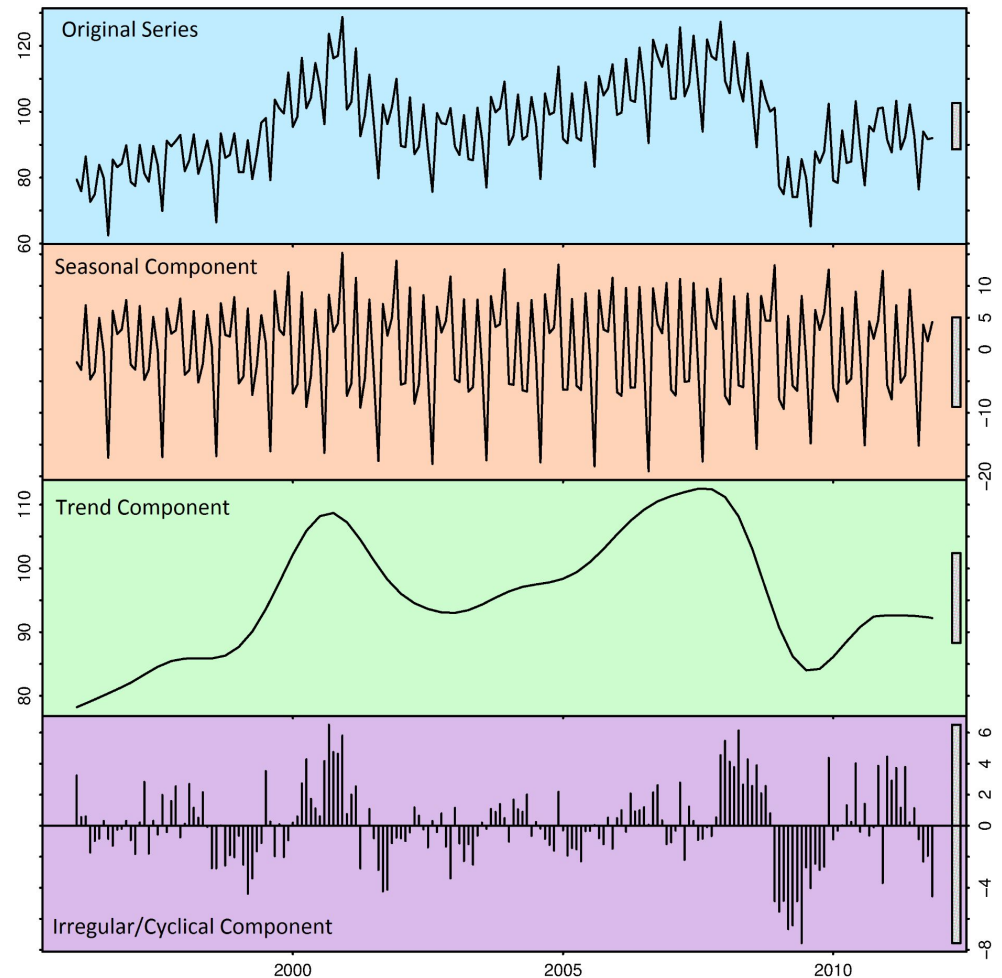

# Time Domain: Differencing and AutoRegressive models

- Differencing: computed differences between consecutive observations
- AutoRegression: Predict value at time  $t$  based on linear combination of past values of variable:  $y_t = \theta_1 y_{t-1} + \theta_2 y_{t-2} + \dots + \theta_p y_{t-p} + \varepsilon_t$
- Order of model is number of lagged values used
- $\theta_1 = 0$  represents white noise
- $\theta_1 = 1$  represents a random walk (with or without constant drift)

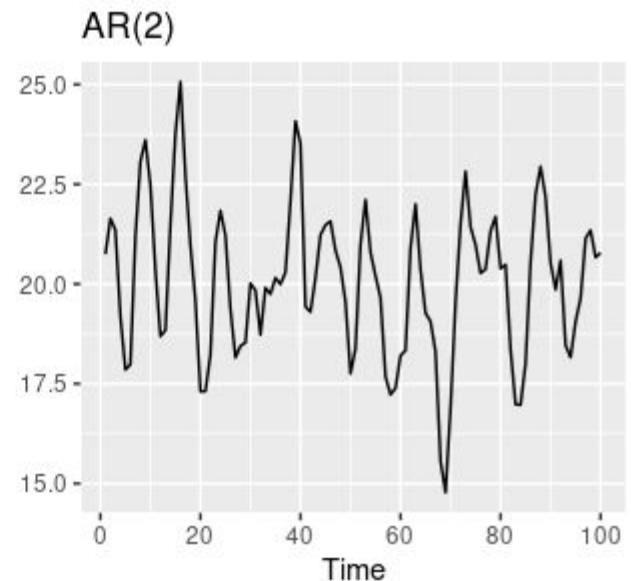
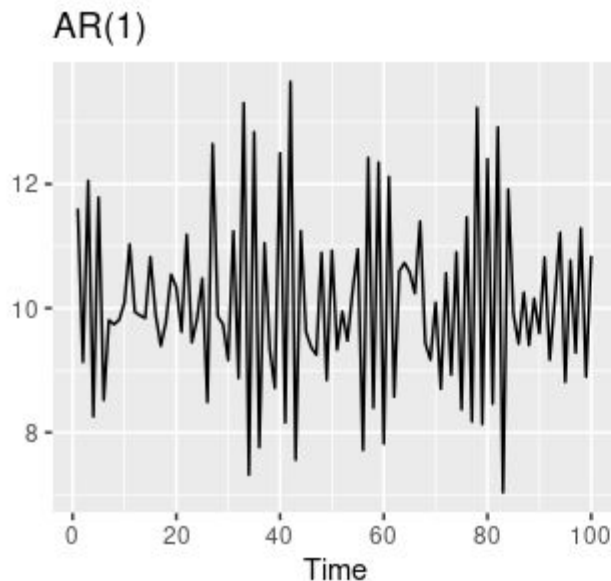

# Time Domain: Moving Average models

- Instead of past values predict using past errors:

$$y_t = \varepsilon_t + \theta_1\varepsilon_{t-1} + \theta_2\varepsilon_{t-2} + \dots + \theta_p\varepsilon_{t-p}$$

- For stationary data  $AR(p) = MA(\infty)$
- Not to be confused with moving average smoothing used in decomposition

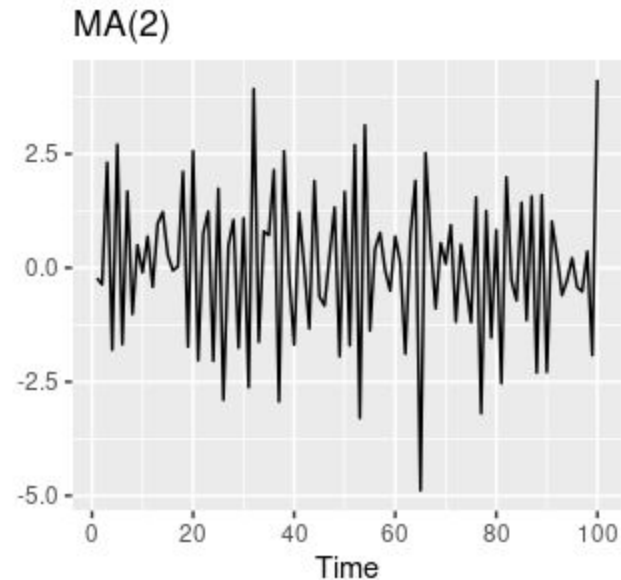
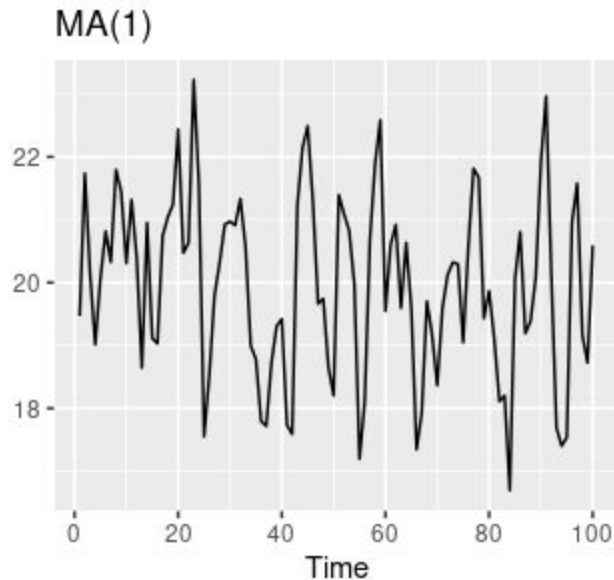



# ARIMA: Combining Differencing, AR and MA models

- AutoRegressive Integrated Moving Average: Predict differenced value of  $y$  ( $y'$ ) using lagged values and errors
- $y'_t = \theta_1 y'_{t-1} + \dots + \theta_p y'_{t-p} + \theta_1 \varepsilon_{t-1} + \dots + \theta_q \varepsilon_{t-q} + \varepsilon_t$
- ARIMA(p,d,q):  $p$  = order of AR,  $d$  = differencing degree,  $q$  = order of MA
- Requires MLE / Information Criterion to fit orders
- Core of gold-standard time-series regression/forecasting method
- More advanced methods:
  - Vector Autoregression (VAR): enables feedback between forecasted variable and predictors (more realistic for real-world data)
  - Feed lagged values (or error) into ML model e.g., neural network with or without convolutions

# Frequency/Spectral Domain

- Signal composed of multiple frequencies (e.g., EEG power bands)
- Can greatly simplify analysis (offers simple decomposition)
- Feeds into many useful mathematical tools (resonance, harmonics, power spectral densities, eigenvalues, ...)
- Several different ways of converting time-domain to frequency-domain
- Laplace and Fourier methods are most common

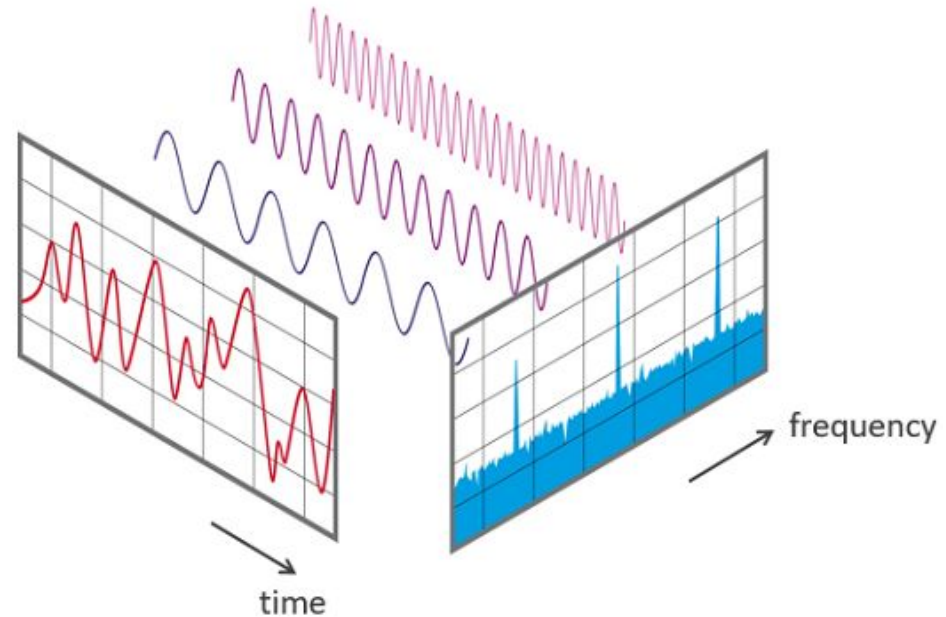

# Frequency Domain: Fourier Transform

- Fourier Transform:

**Time -> Frequency**

- Inverse Fourier Transform:

**Frequency -> Time**

- Decompose signal into series of angular components

$$x(t) = a \sin(\omega t + \varphi) = a \sin(2\pi f t + \varphi)$$

- Location (frequency) and height (amplitude) of frequency spectra peaks (among other statistical summaries of spectral space) can be used as input for whatever model you want.

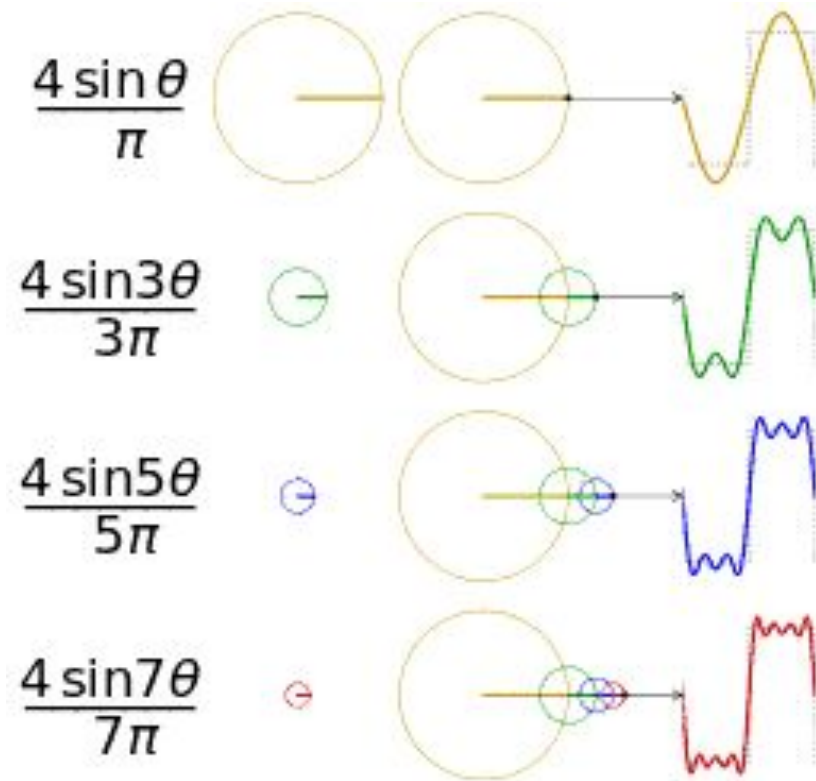

# Time-Frequency Domain: Wavelet Transforms

- Fourier transform has great frequency resolution but no time resolution
- Wavelet allows retaining frequency and time resolution: capture dynamic frequency spectra within signal
- Convolve signal with variety of waves (wavelets) with scale (frequency) and location (time) properties
- Wavelet can be learnt a la convolutional kernels

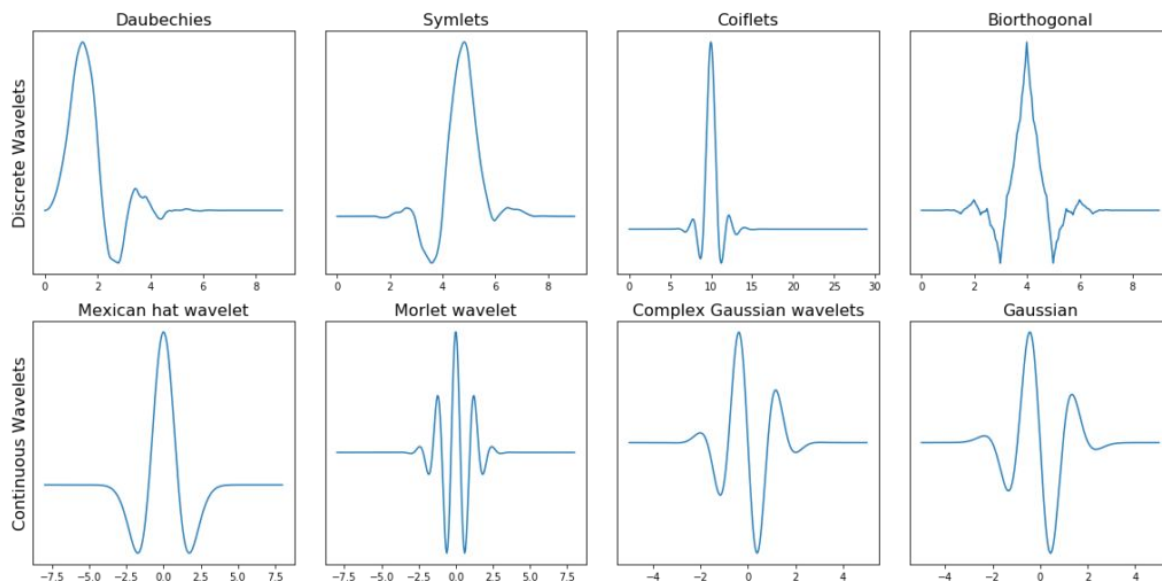

# State-space models: Hidden Markov Models

- Data is represented resulting from a series of hidden states
- Model describes movements between hidden states
- Observed values are derived from hidden states
- Markov property: only previous state(s) matter
- More naturally discrete time (but continuous time possible)
- Well suited to classification/detection

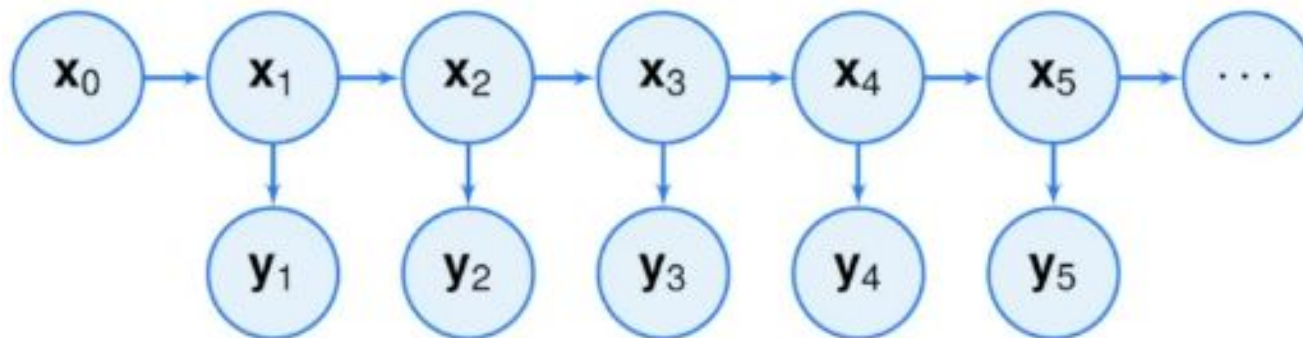

► A canonical **state space** model:

$$\begin{array}{ll} \text{Dynamics:} & \mathbf{x}_k = \mathbf{f}(\mathbf{x}_{k-1}, \mathbf{q}_k), \quad \mathbf{q}_k \sim \mathcal{N}(\mathbf{0}, \mathbf{Q}_k), \\ \text{Measurement:} & \mathbf{y}_k = \mathbf{h}(\mathbf{x}_k, \mathbf{r}_k), \quad \mathbf{r}_k \sim \mathcal{N}(\mathbf{0}, \mathbf{R}_k) \end{array}$$

# Going beyond HMMs

- RNNs can act like HMMs more complex dependencies
- Alternative state space models: best of both worlds
- Attention mechanism similar to soft/variable-order HMMs

**Maintain probabilistic structure of HMMs**

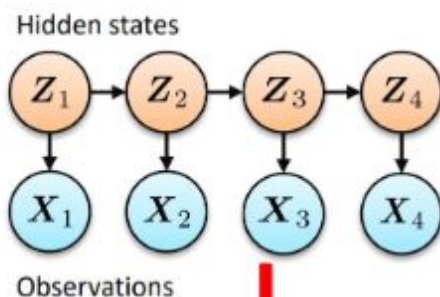

**But use RNNs to model state dynamics**

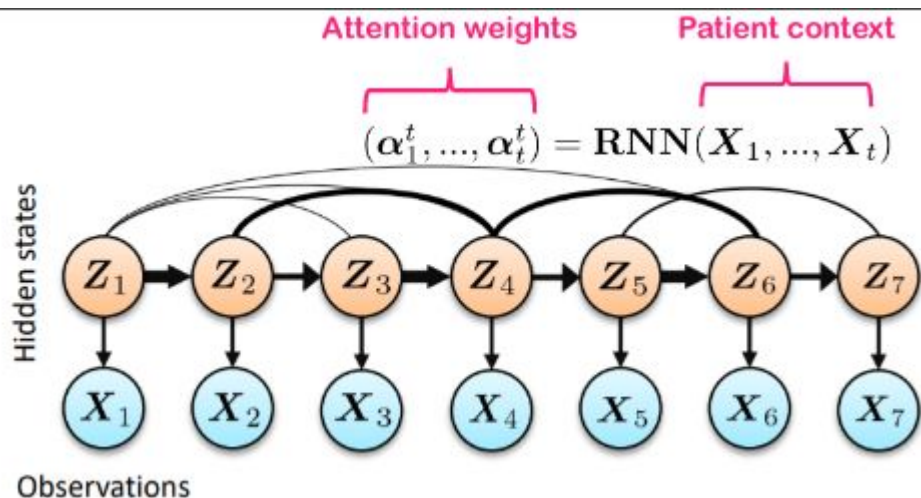
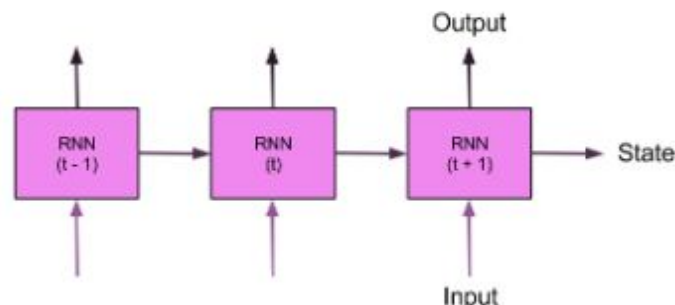

# Decomposing data from multiple sensors

- Measured medical phenomena are often a mixture of signals from different sources
- Multiple sensors = each captures those sources (or a subset)
- Same source through different sensors will have different characteristics (amplitude, lag) due to sensor location

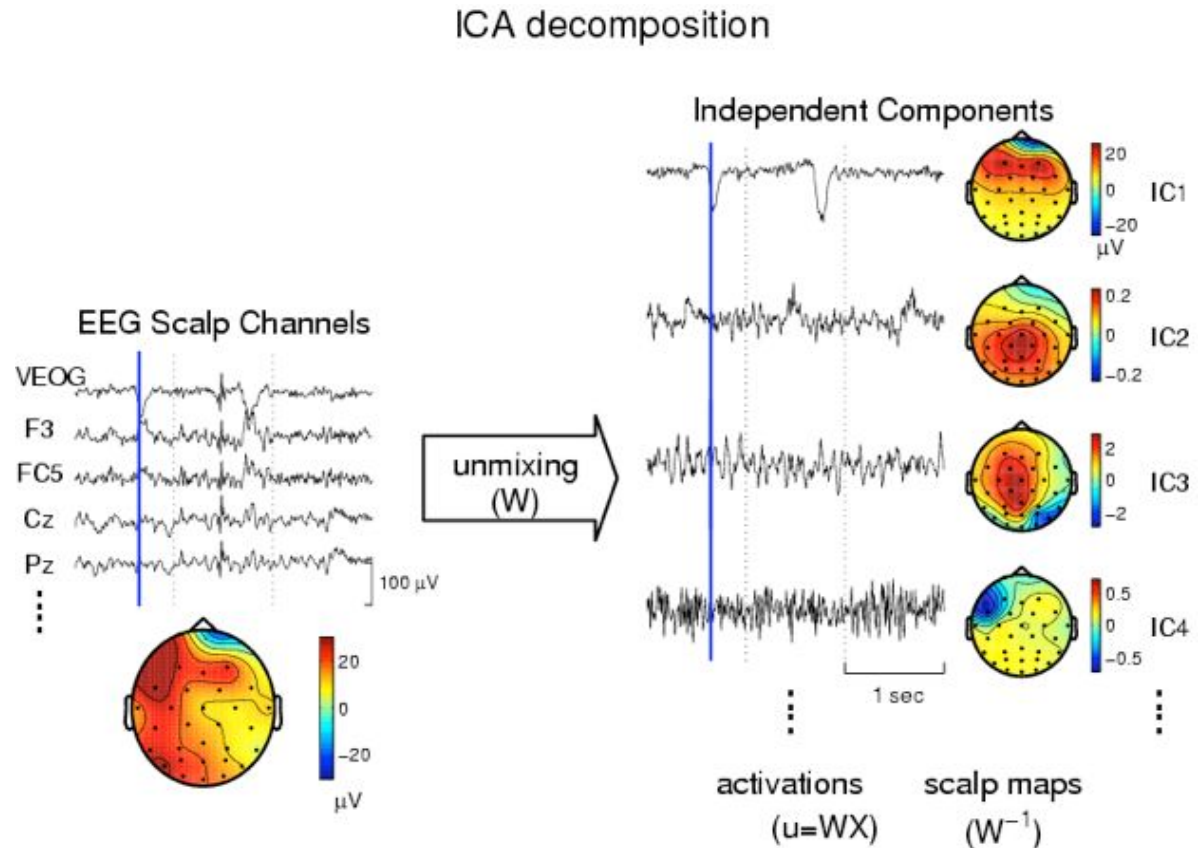



# Decomposing data from multiple sensors: Independent Component Analysis

- Decompose signal into linear mixture of independent sources
- Part of most EEG analysis/processing workflows
- “Sphering” data (remove correlations between channels: cholesky decomposition with covariation matrix)
- Identify gaussian components of sphered (aka “whitened”) matrix

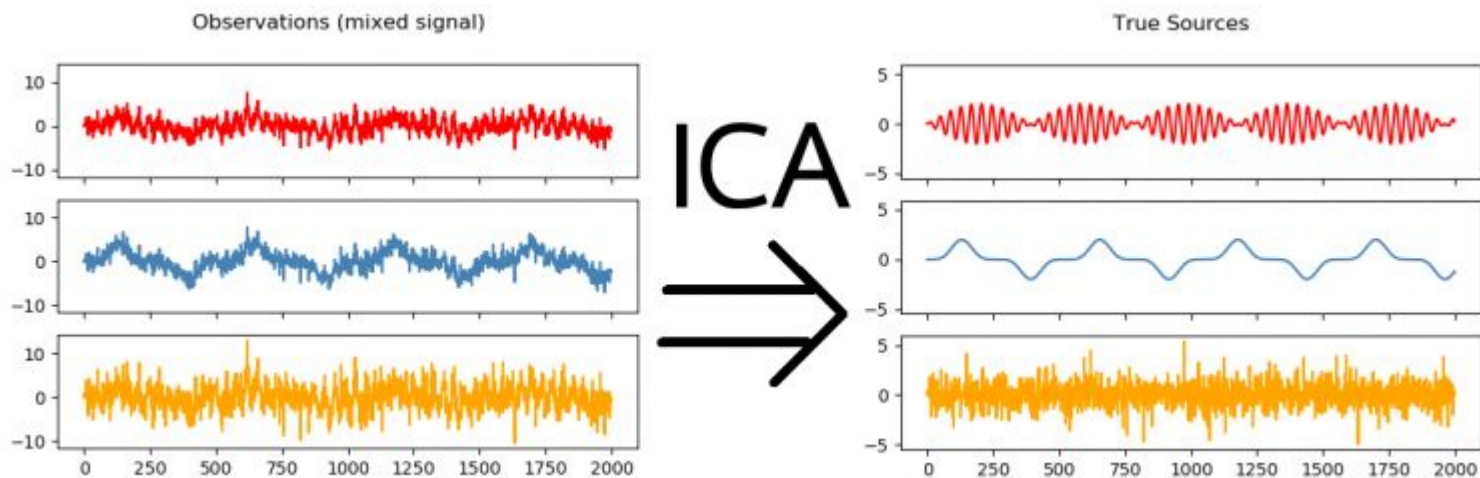



# Gaussian Processes: non-parametric models with infinite parameters

- Bayesian linear regression: find distribution over the parameters consistent with observed data
- Gaussian process: find distribution over all possible functions that are consistent with observed data
- Defined by covariance kernel between functions (draws from multivariate gaussian)
- Can capture time, frequency, and state-space models
- Yet another “should be an entire graduate course”

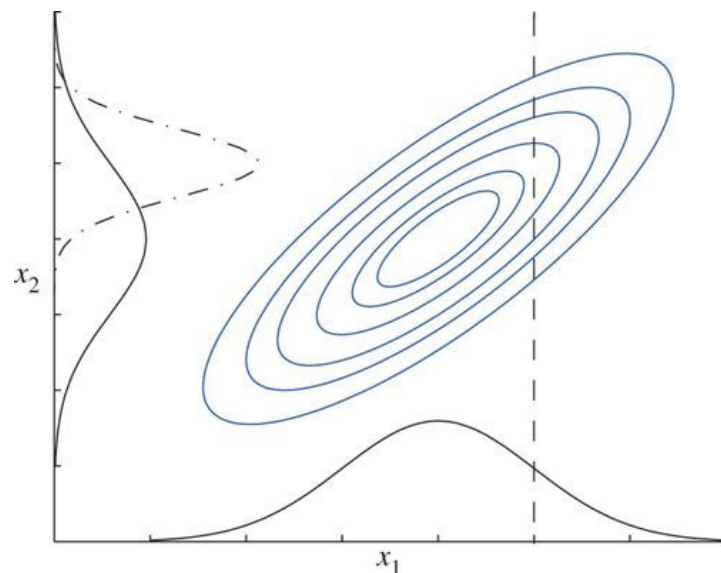

# Gaussian Process Prior

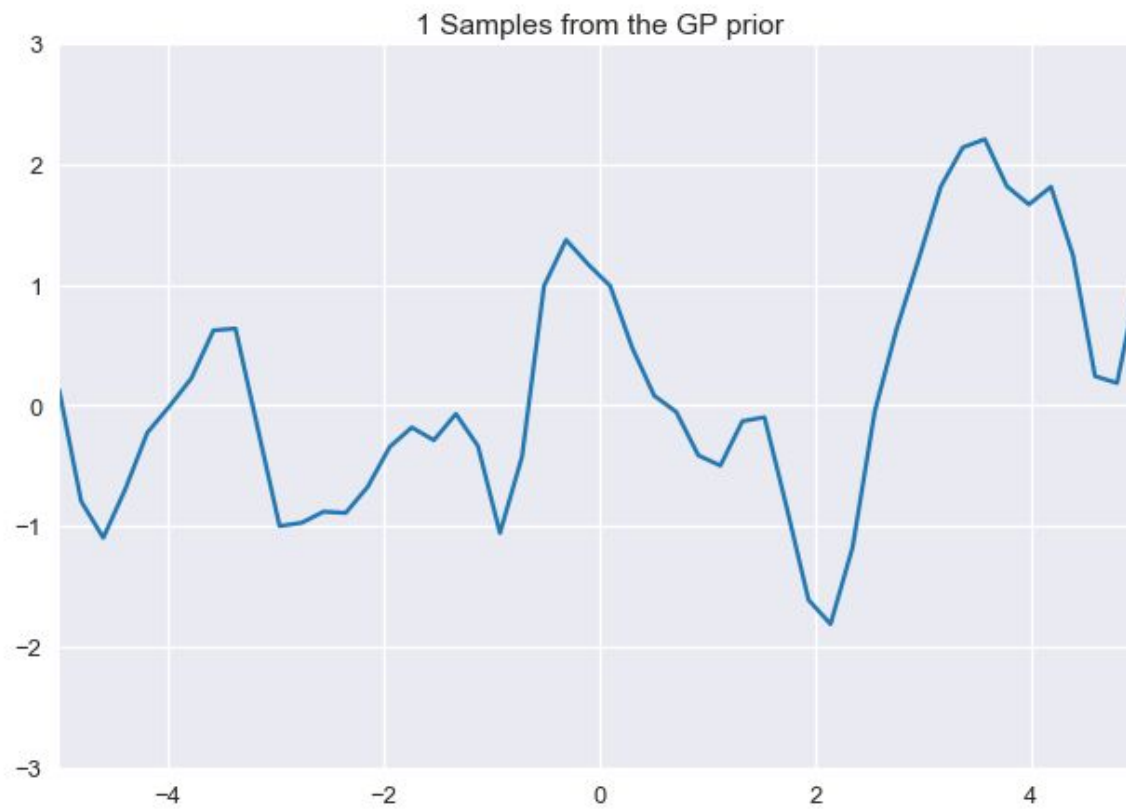

# Gaussian Process Prior



# Gaussian Process Prior

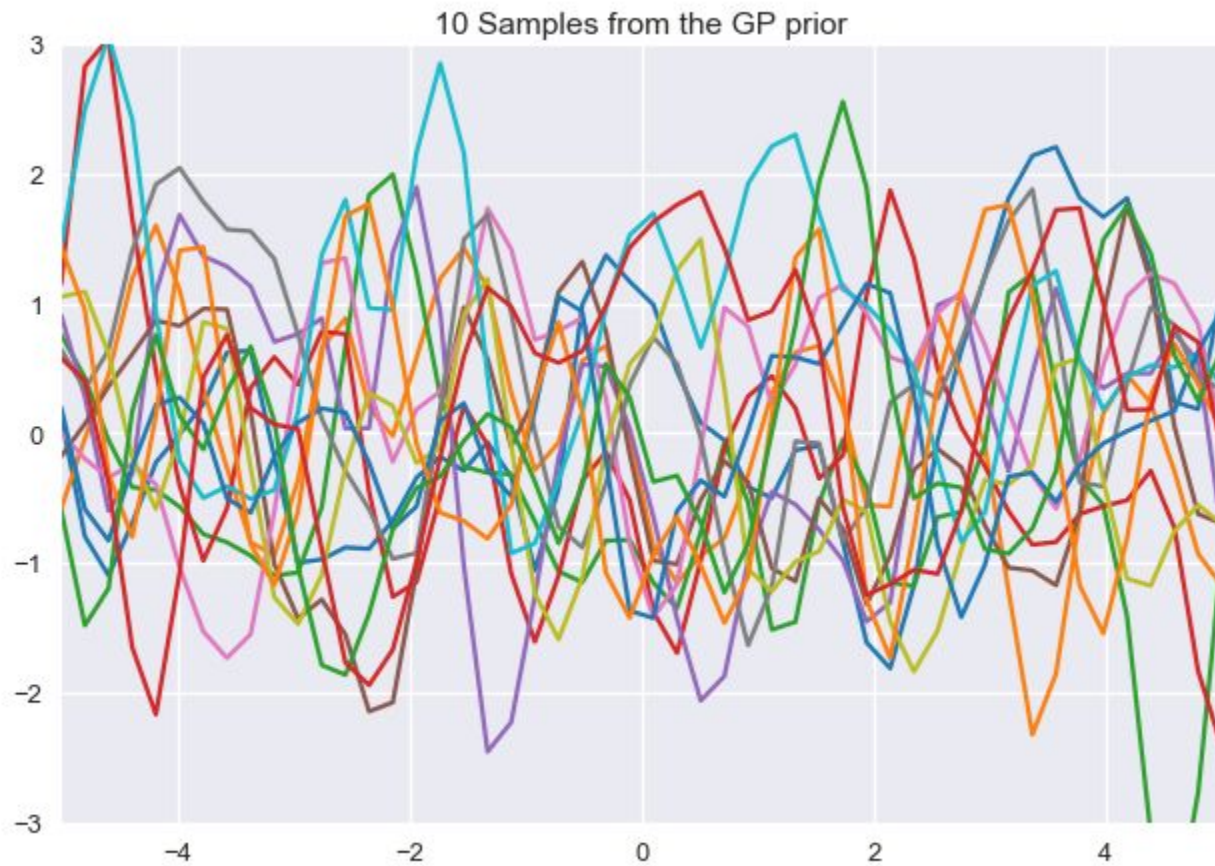

# Gaussian Process Prior

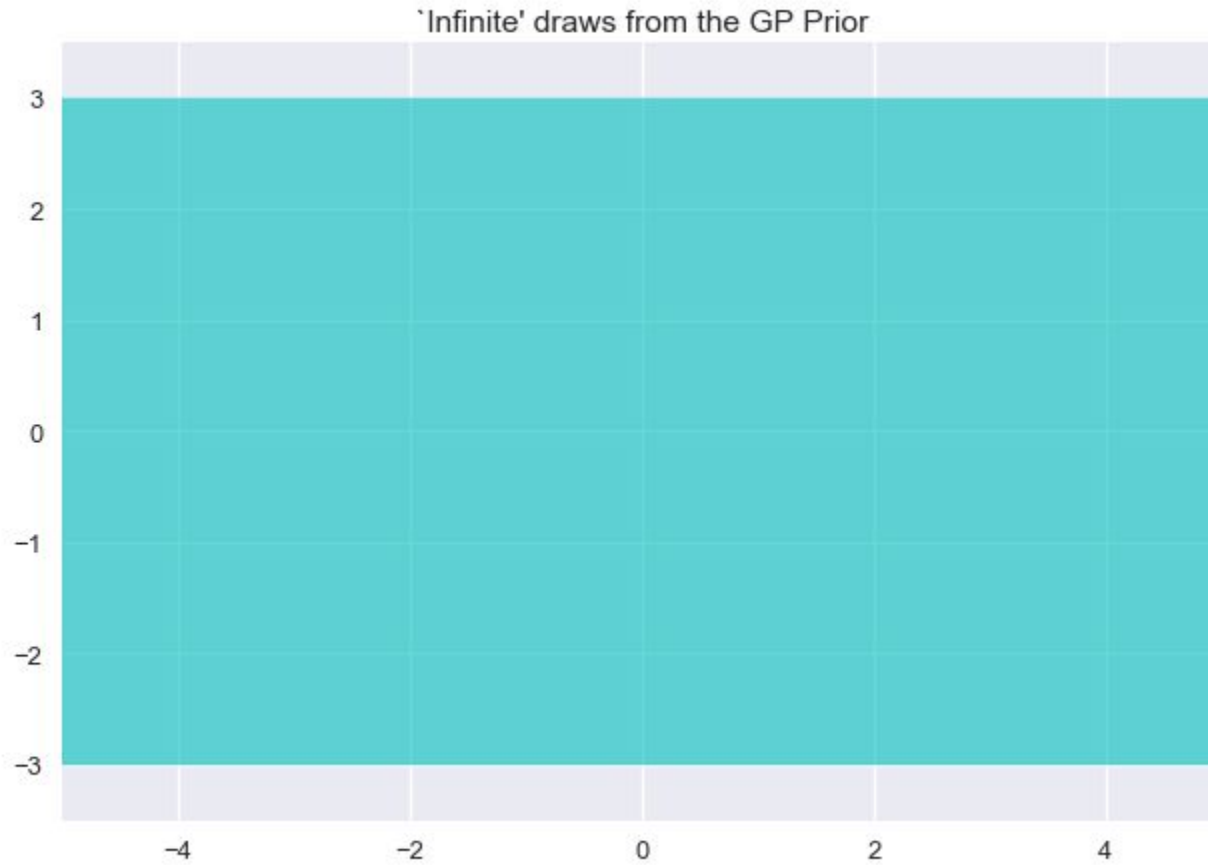

# Constrain prior based on observed data: posterior

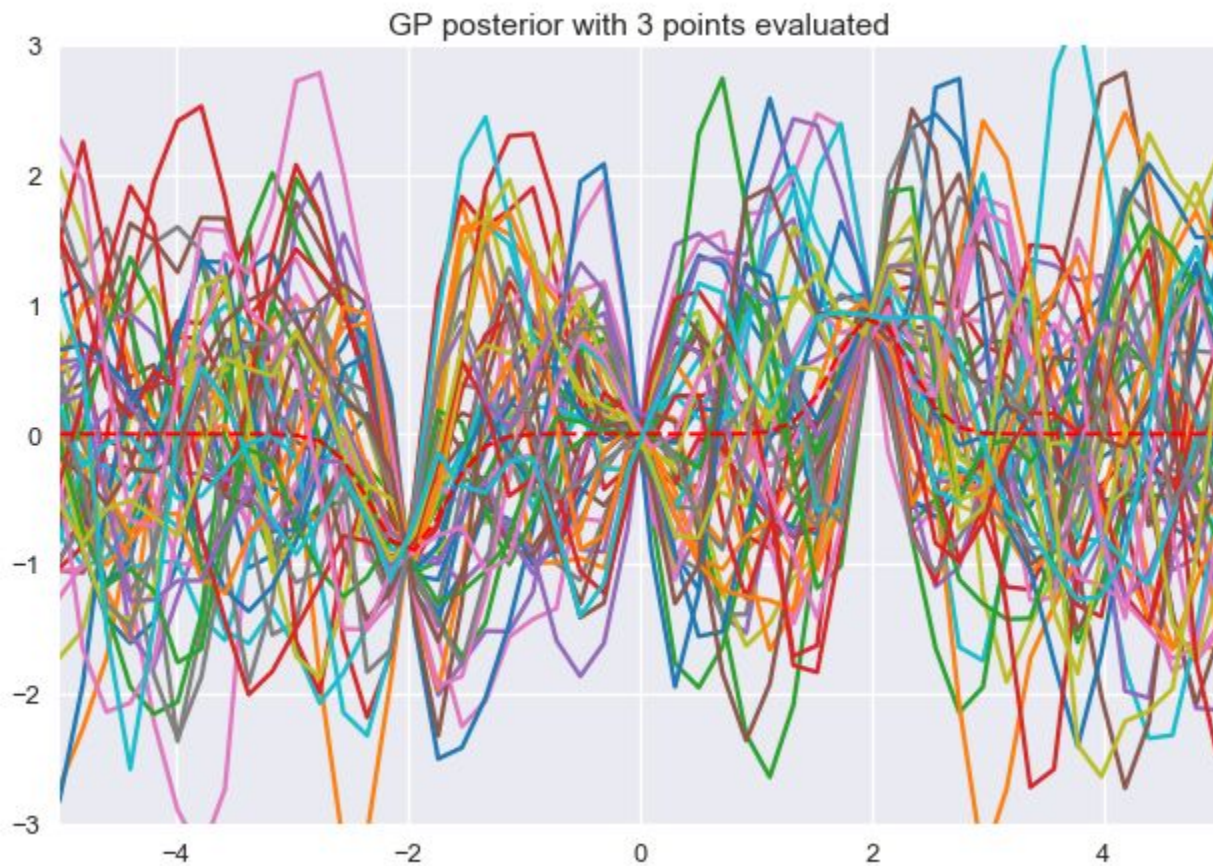



# Constrain prior based on observed data: posterior



# Constrain prior based on observed data: posterior

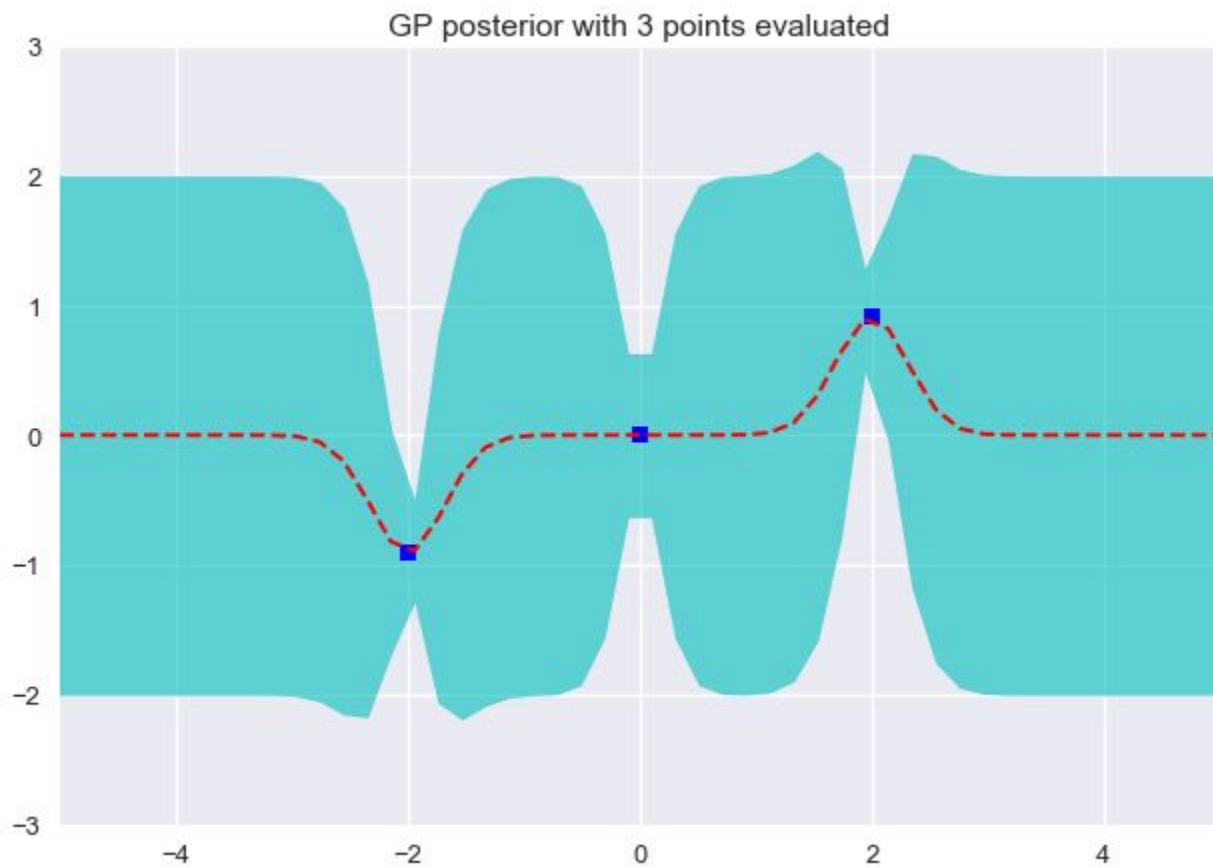



# Probabilistic numerics: data efficient framework

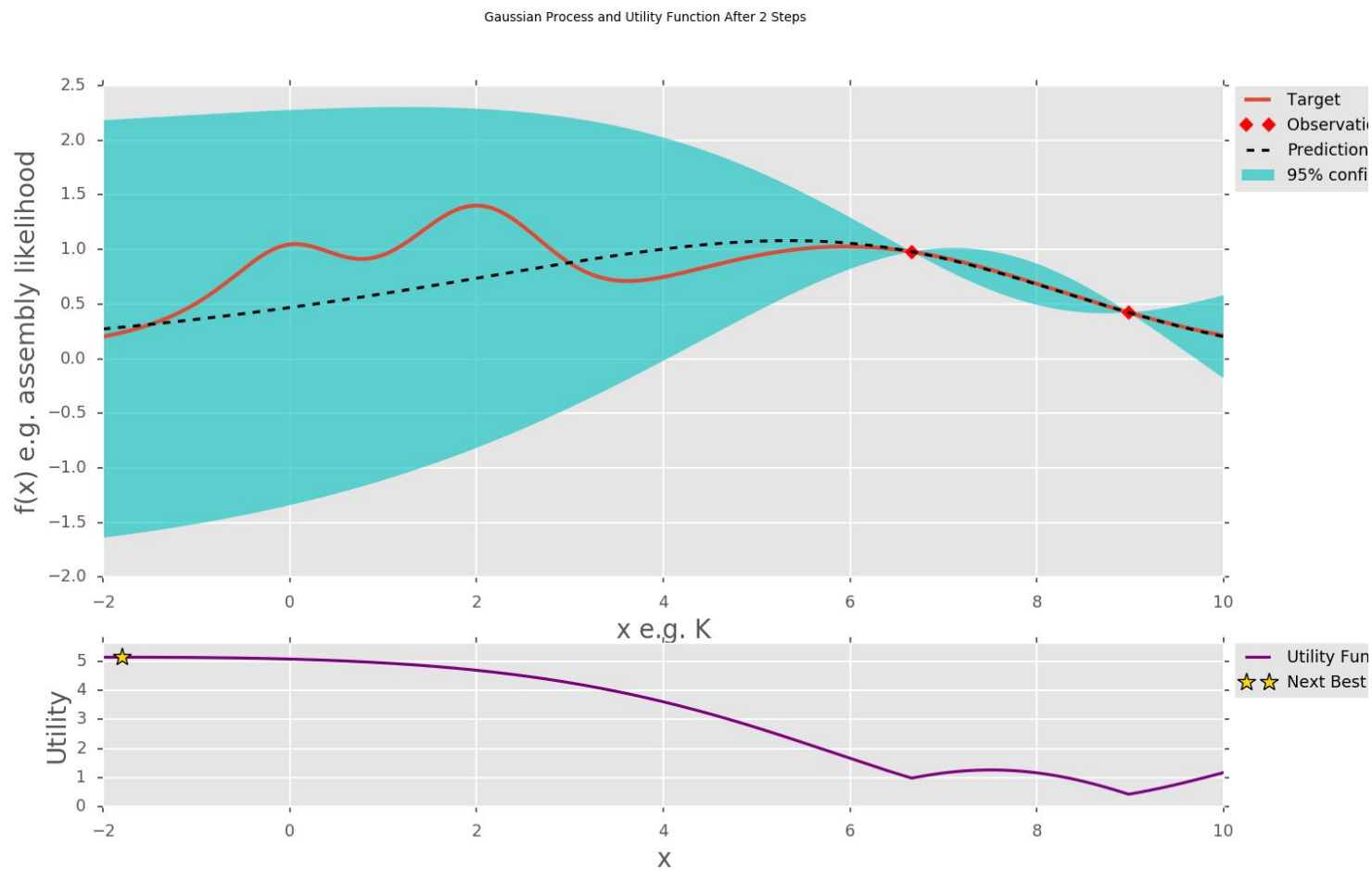

# Probabilistic numerics: data efficient framework

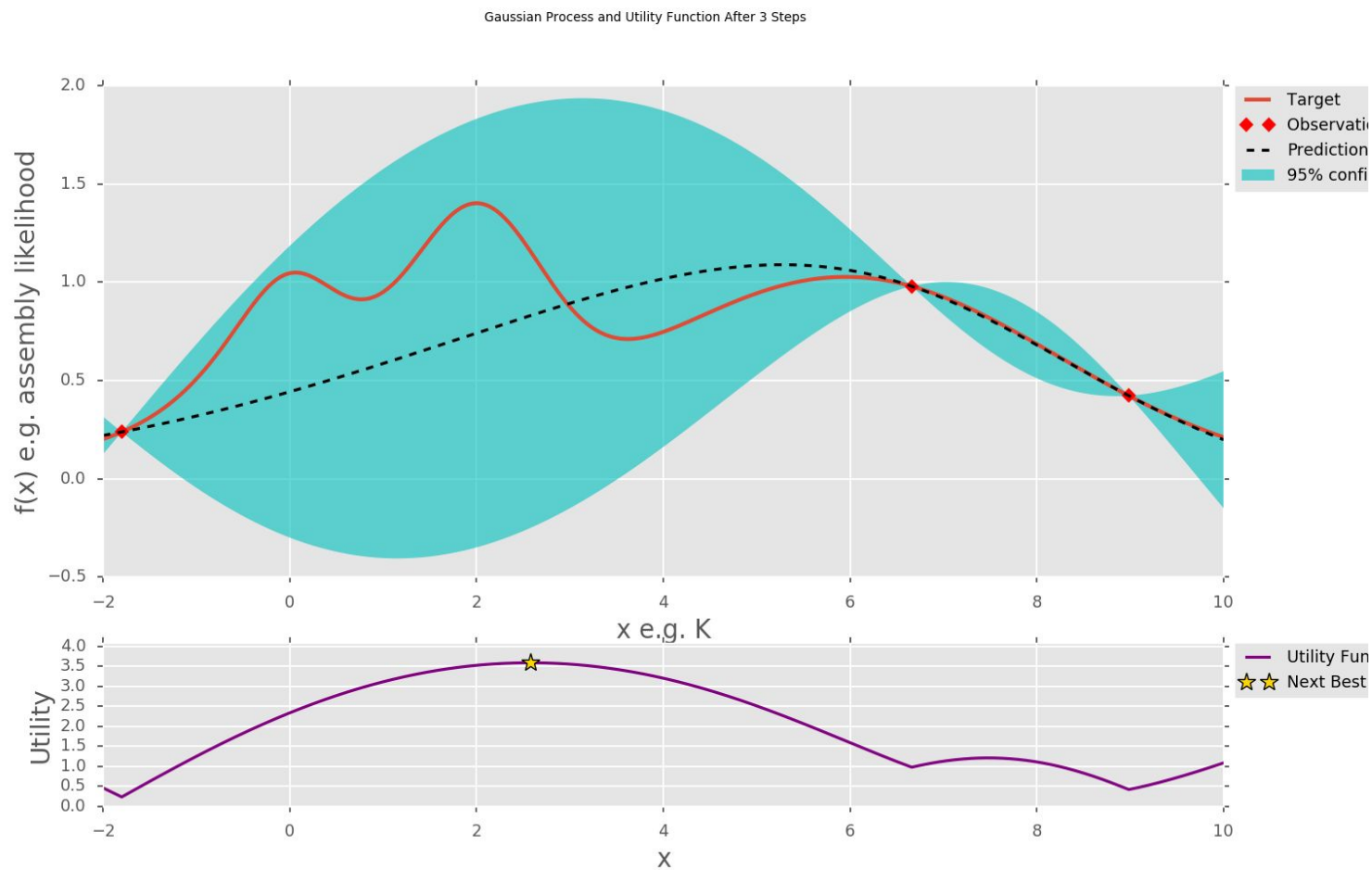

# Probabilistic numerics: data efficient framework

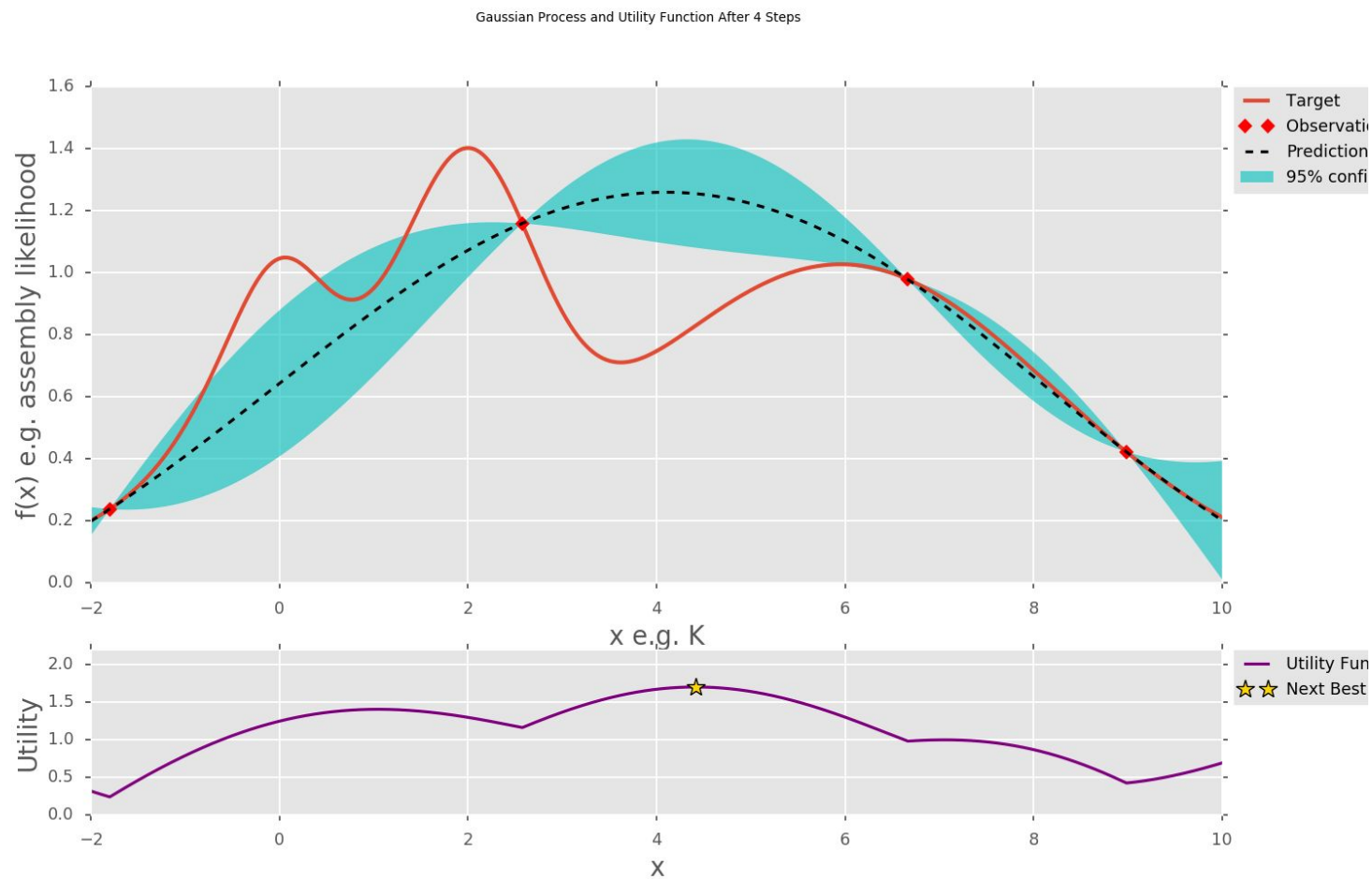

# Probabilistic numerics: data efficient framework

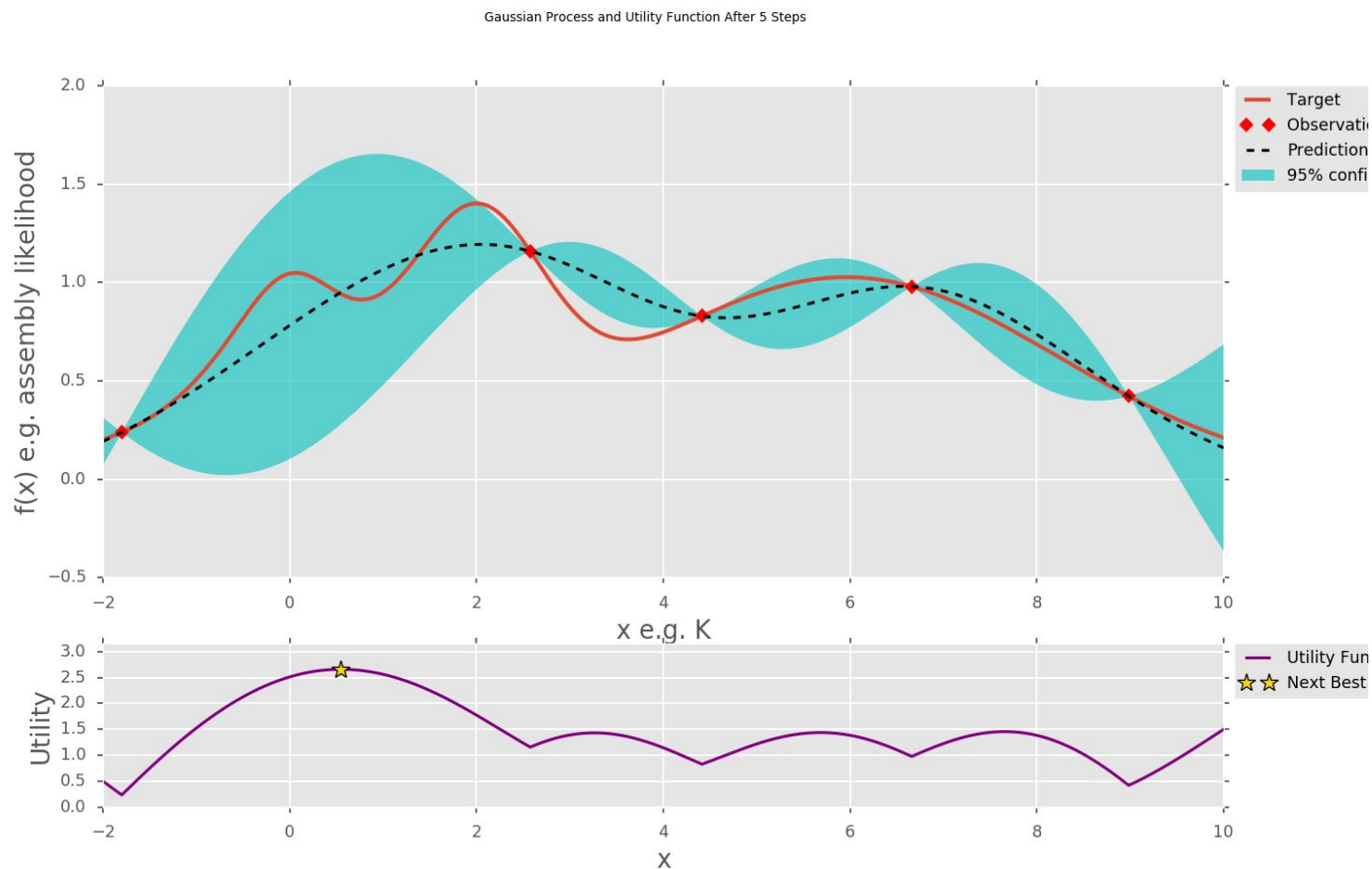

# Probabilistic numerics: data efficient framework

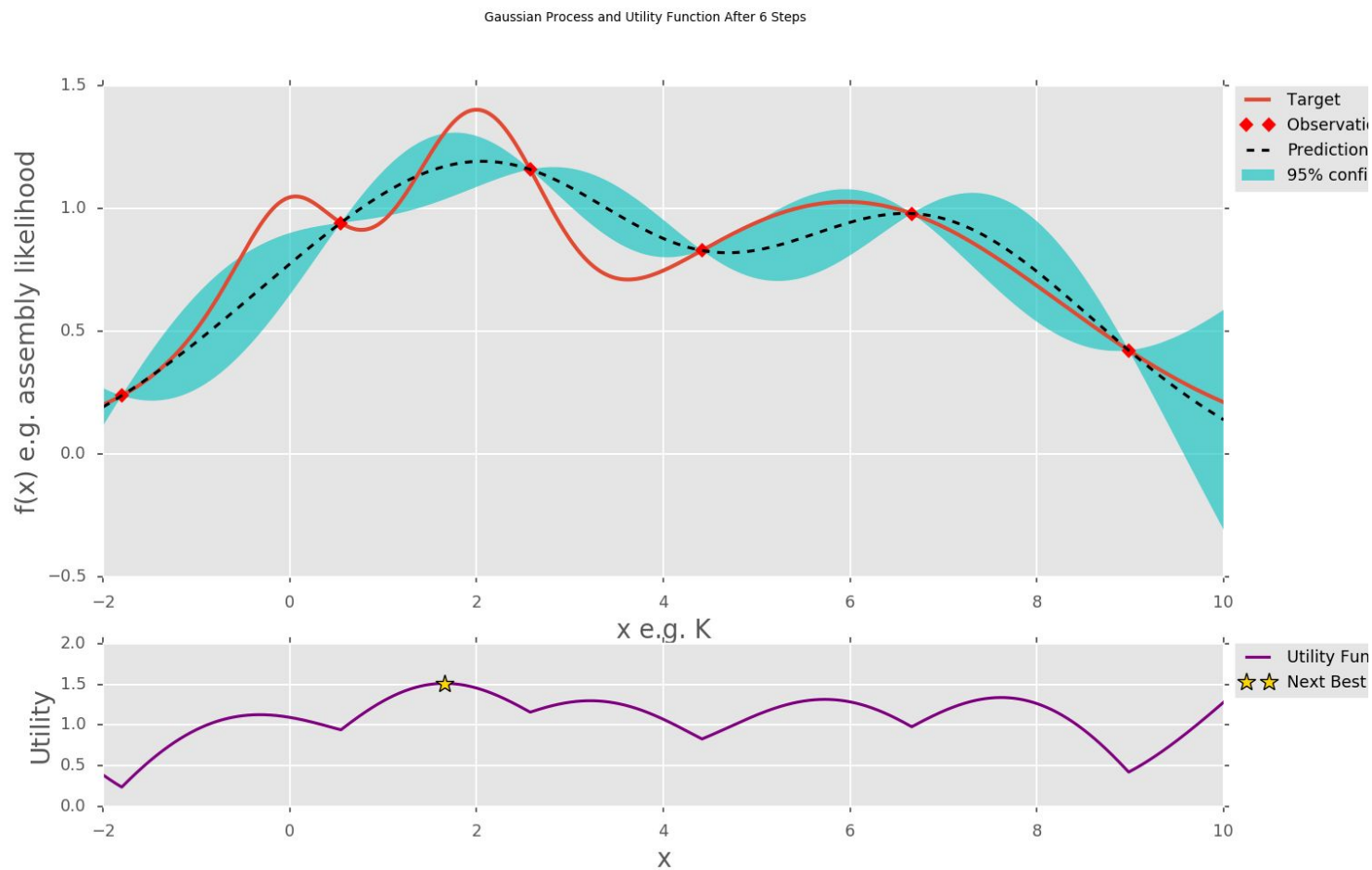

# Probabilistic numerics: data efficient framework

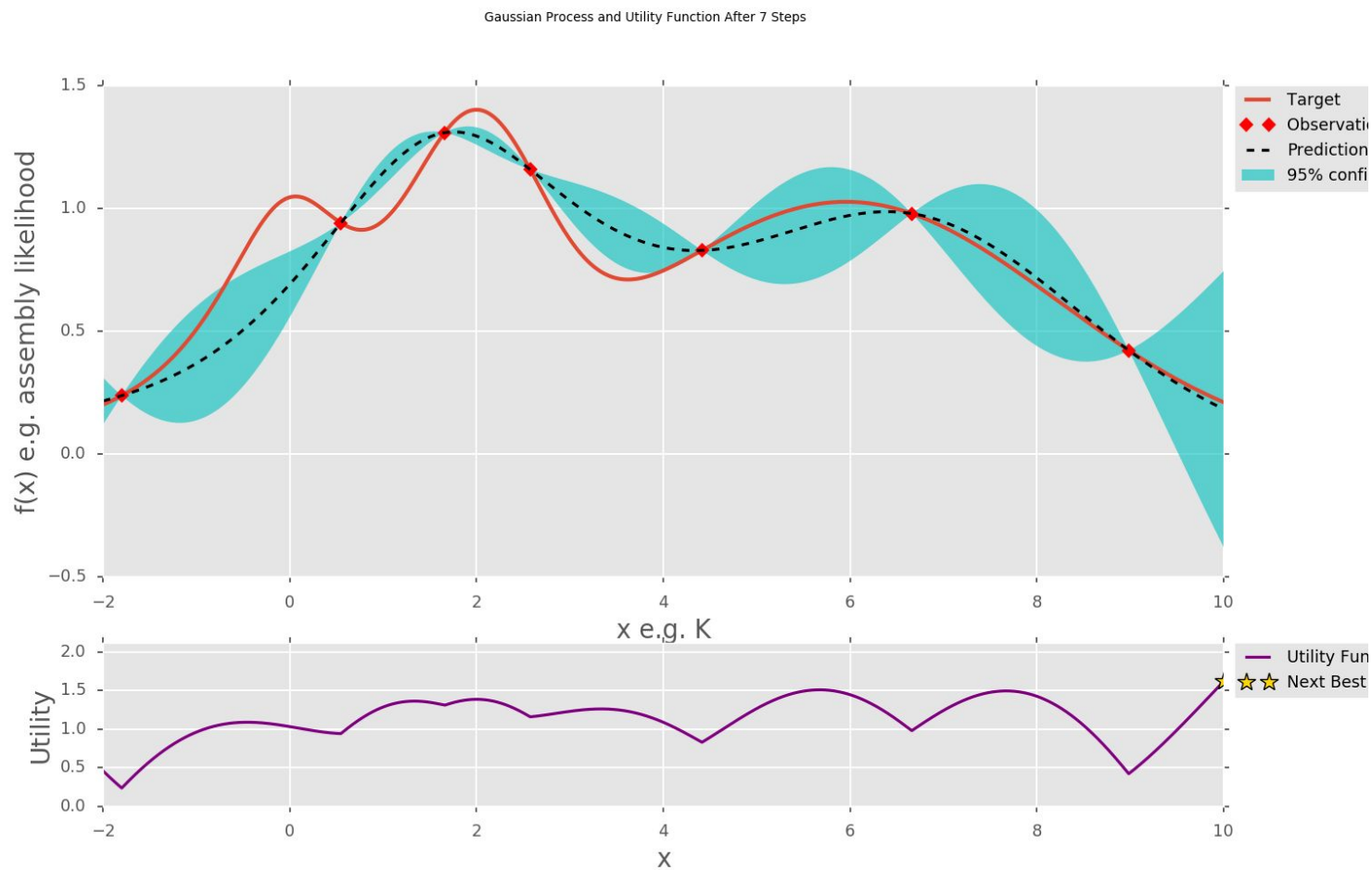

# Probabilistic numerics: data efficient framework

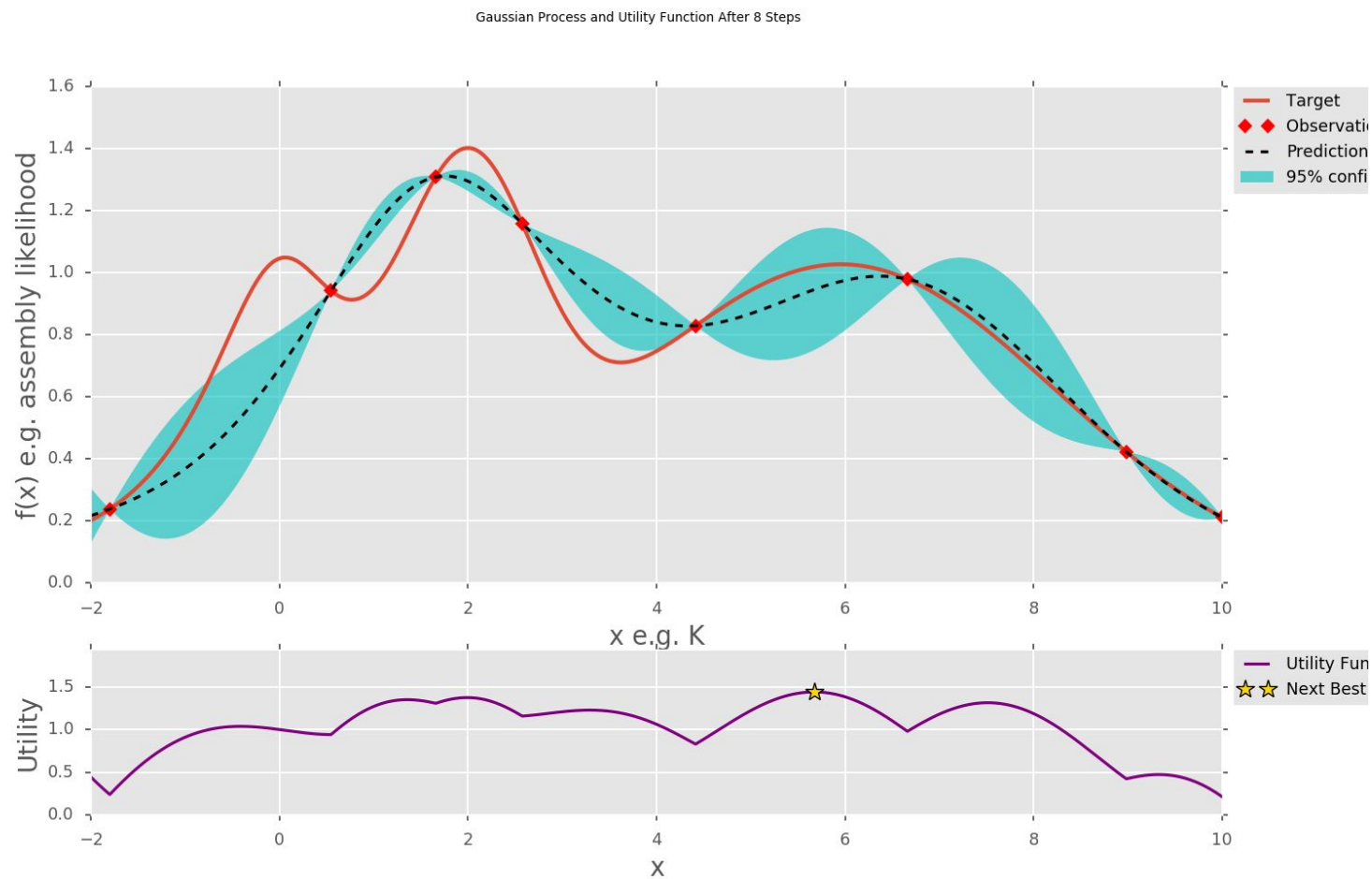

Let's discuss some case studies



# Cough detection/classification

- Quick/Non-invasive screening of COVID-19 could protect health resources/optimize non-pharmaceutical interventions
- Crowdsourced cough recordings

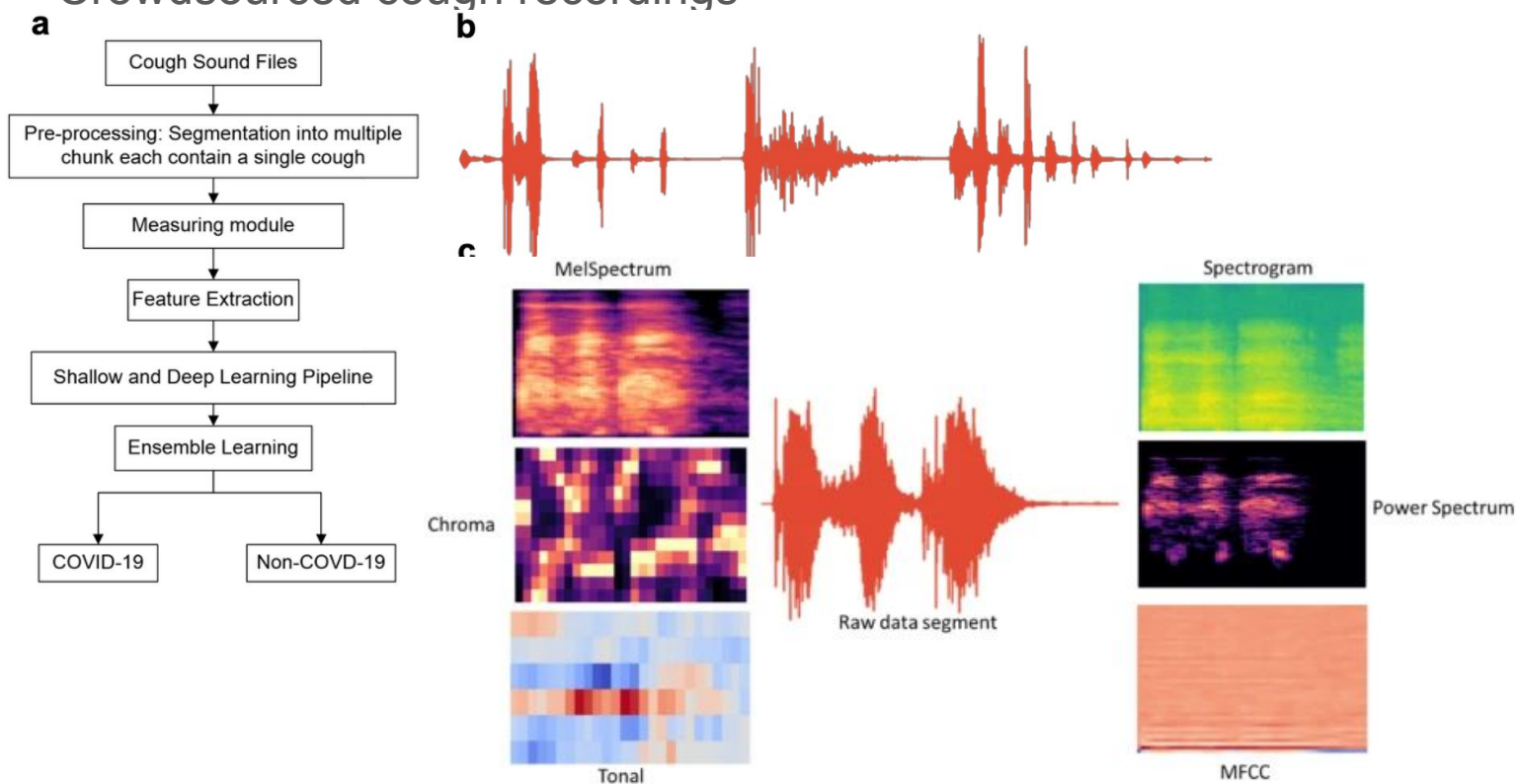

# Cough detection/classification

Feature/classifier	NB		KNN		LogitReg		RF		SGD		XGB		SVM	
	Pre	NPV	Pre	NPV	Pre	NPV	Pre	NPV	Pre	NPV	Pre	NPV	Pre	NPV
Chroma	0.52	0.50	0.53	0.53	0.54	0.54	0.53	0.53	0.55	0.54	0.51	0.51	0.54	0.55
MelSpectrum	0.68	0.55	0.63	0.63	0.64	0.64	0.63	0.61	0.58	0.59	0.61	0.62	0.64	0.63
MFCC	0.55	0.64	0.60							0.59	0.61	0.63	0.68	0.64
PowerSpec	0.54	0.58	0.60							0.57	0.61	0.61	0.63	0.63
RAW	0.59	0.53	0.60							0.52	0.56	0.58	0.61	0.59
Spec	0.56	0.57	0.65	0.66	0.63	0.66	0.68	0.68	0.60	0.62	0.65	0.65	0.73	0.68
Tonal	0.53	0.63	0.53	0.55	0.55	0.55	0.56	0.56	0.51	0.51	0.57	0.53	0.53	0.54

CNN/VGGish transfer: Precision  
~0.65

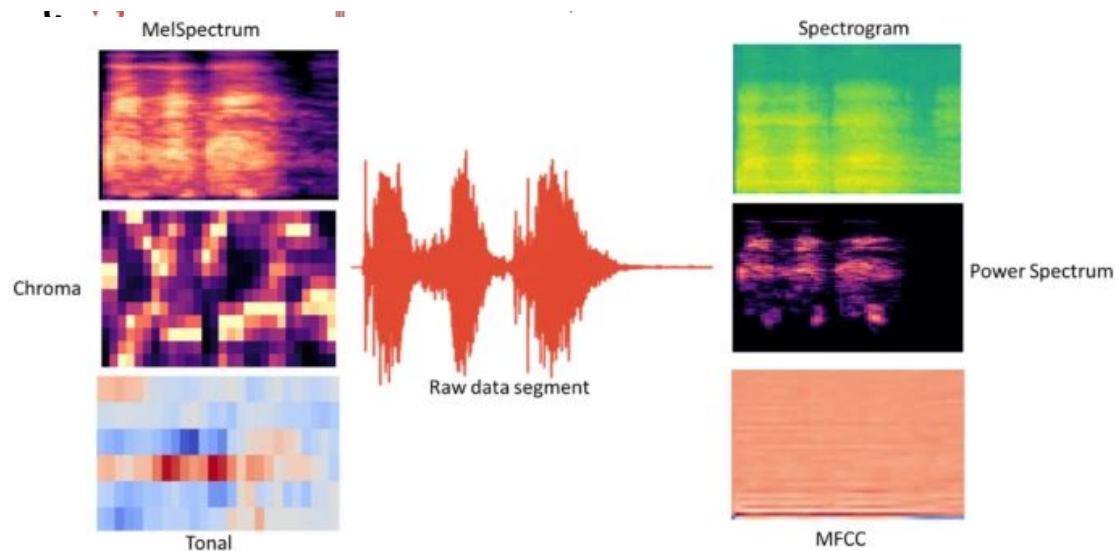
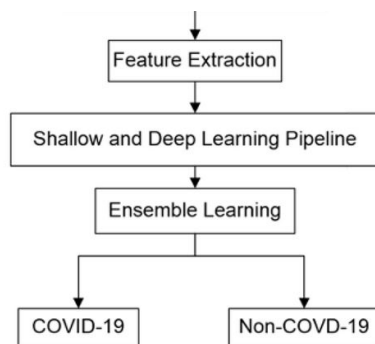

# Electrocardiogram (ECG)

Many useful and useless analyses of ECGs:

- Predict age and sex
- Detect anaemia (>90% accuracy with demographic data)
- Predict likelihood of low ejection fraction
- Automated detection of amyloid heart/cardiomyopathy/mitral valve prolapse
- Predict 1-year mortality (AUC > 0.85)

Methods generally require some form of ECG segmentation:

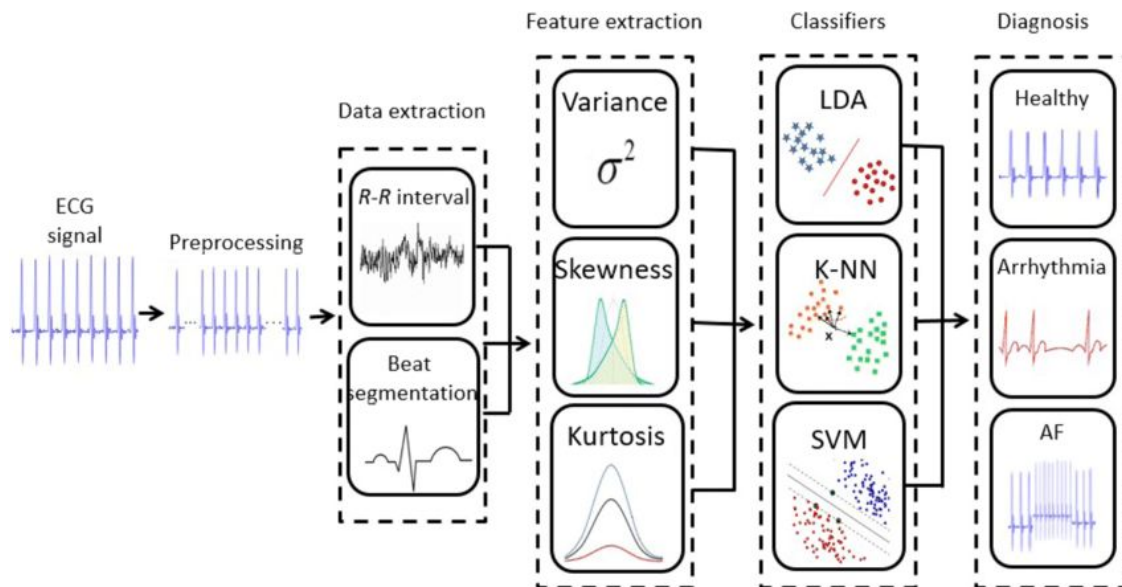

# Dynamic Time-Warping beat segmentation

- Clean ECG: just identify highest peaks but ECG is often noisy
- Know what a heartbeat looks like: align to ECG
- Often detecting arrhythmias/abnormal heartbeats: may not align
- Allow time to be “fuzzy” in alignment: dynamic time warping

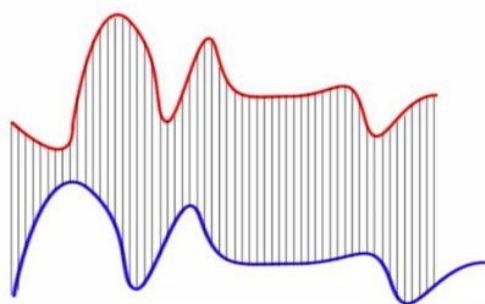
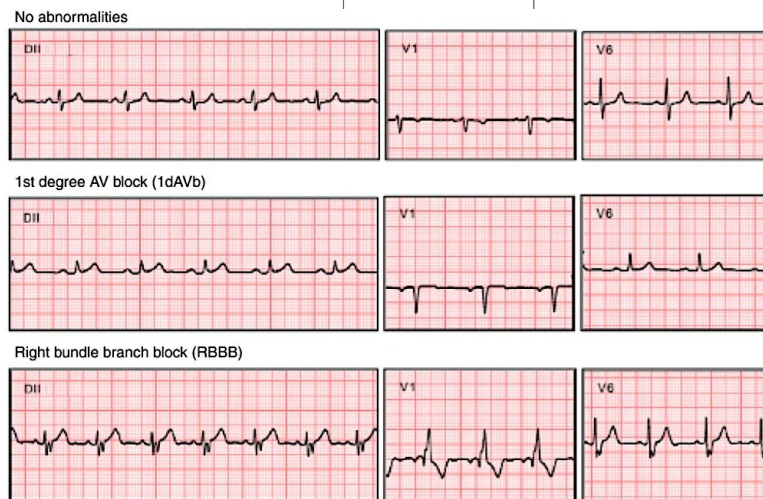
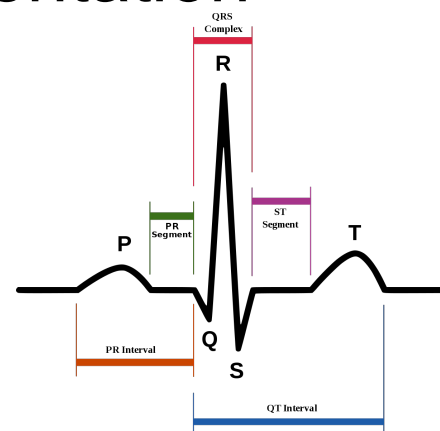

Euclidean Matching

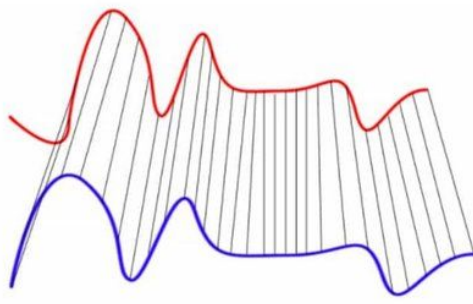

Dynamic Time Warping Matching

# Wavelet Transform Beat Segmentation

- Wavelet transforms can make R-peaks very clear even in noisy data
- Hand-crafted features can then be extracted
- Alternatively deep models can be used to learn wavelets and segmentations (unsupervised or supervised)

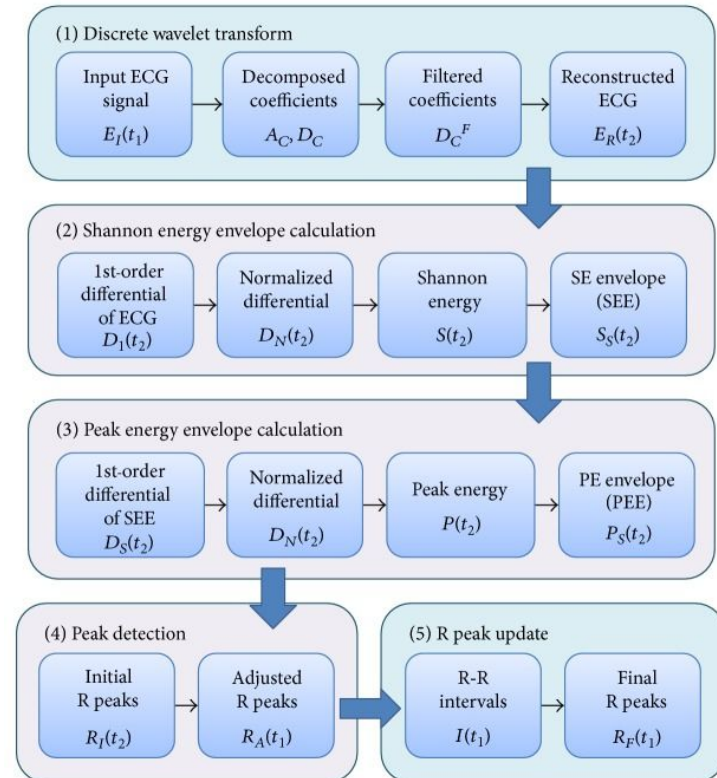
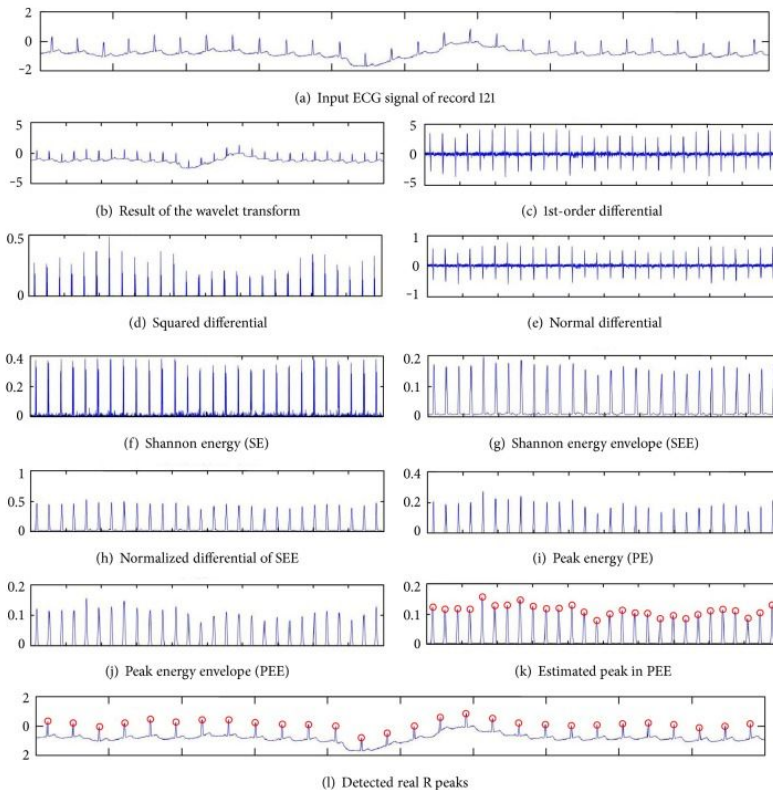



# Predicting epileptic seizures

- Epilepsy has a global prevalence of 1% (80 million)
- 30% of cases not treatable with anti-epileptic medication (2.4 million)
- Unpredictability of seizures is major source of mortality and morbidity
- Permanent intracranial EEGs now possible

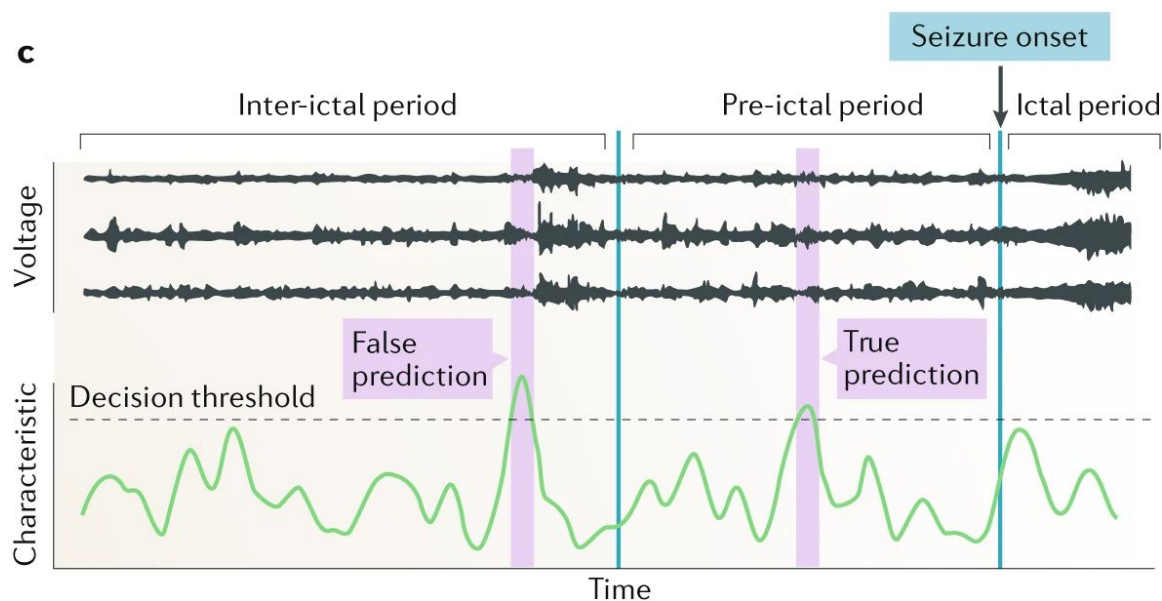
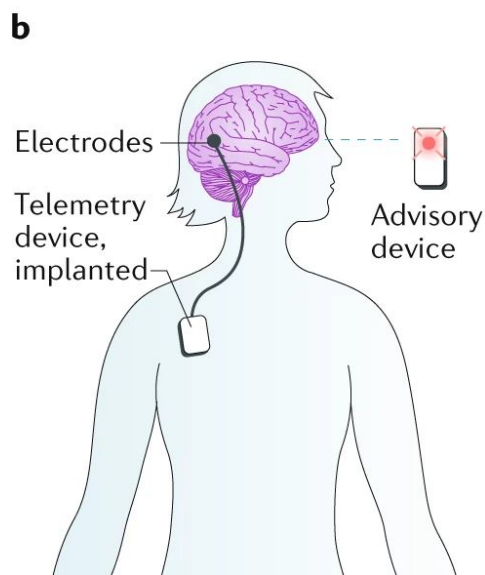

# Lots of research

- 2007 review: insufficient evidence that seizures can be predicted

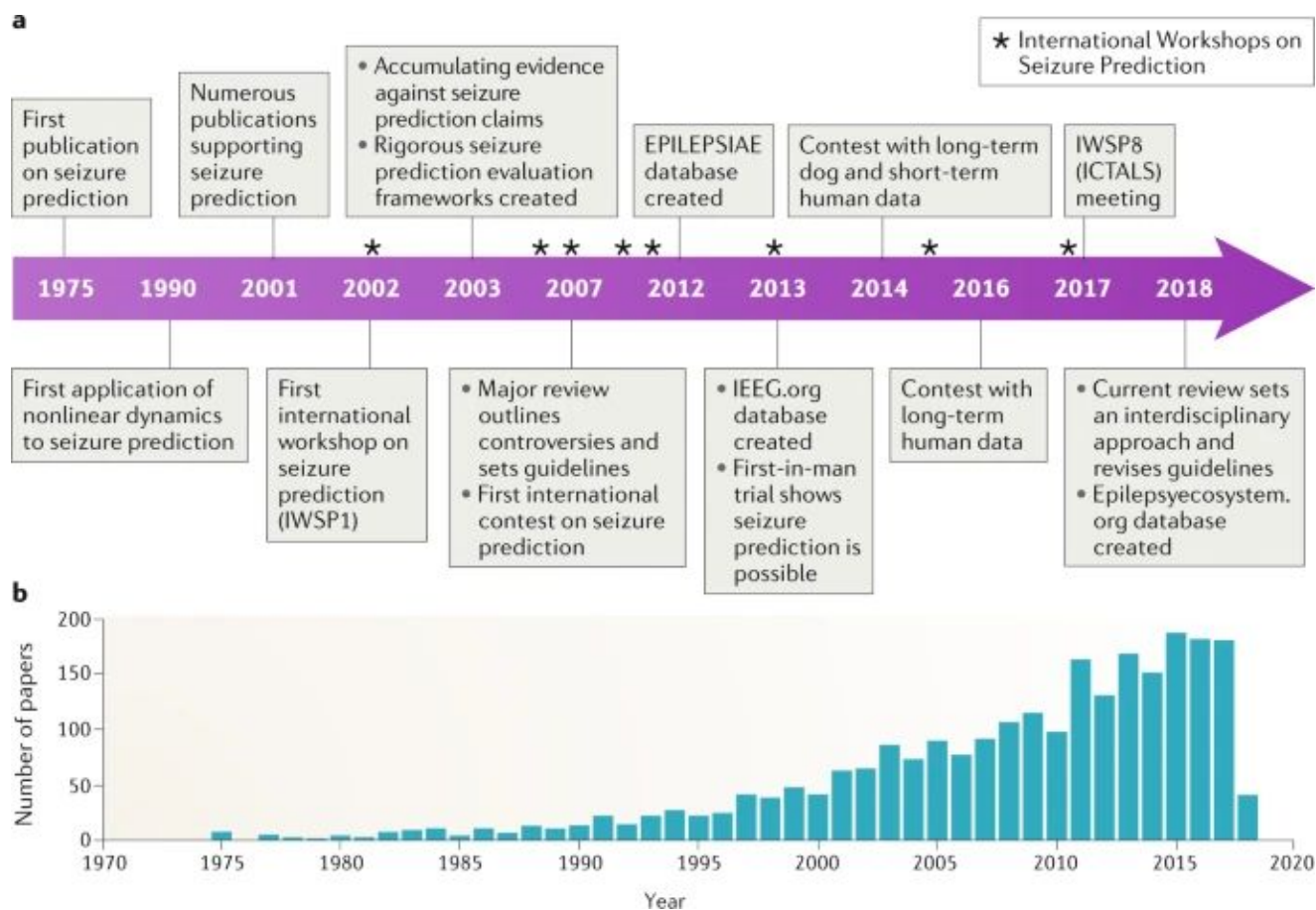



# Nulls for periodic signal can be challenging

- Randomly shuffle seizure onset times => no pre-2007 actually worked

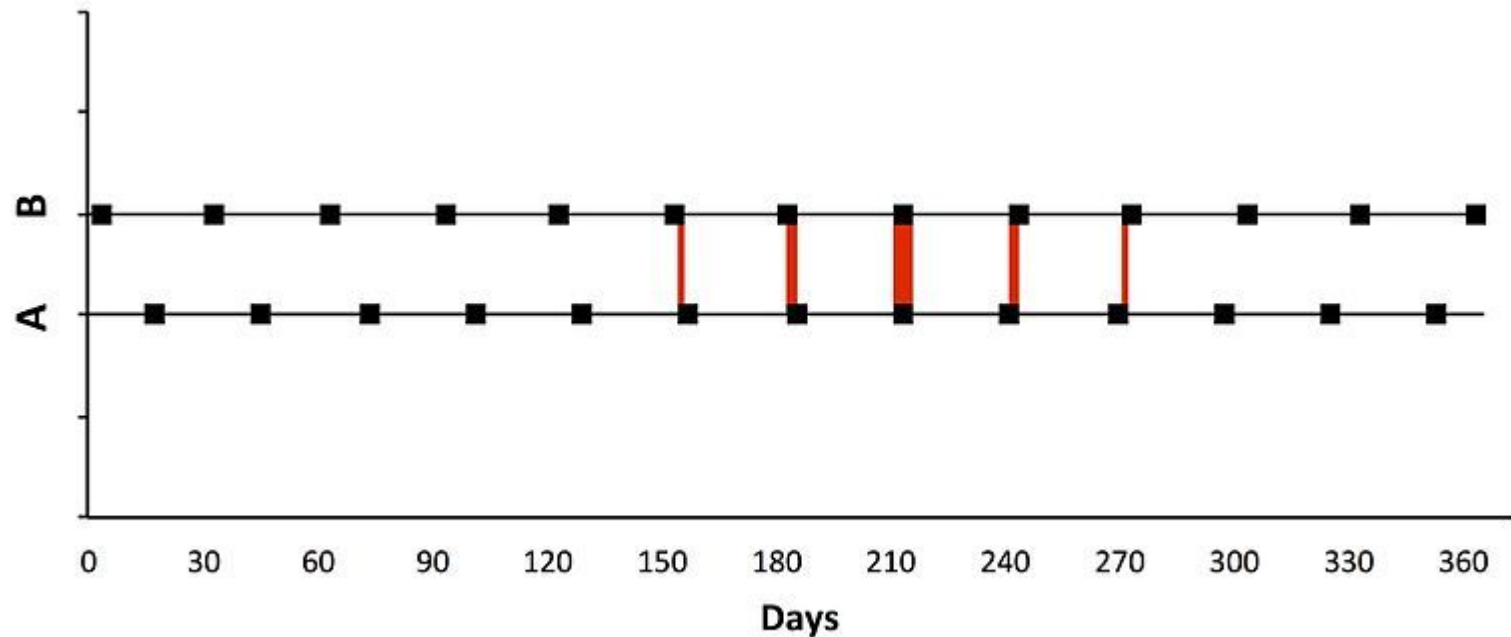

[https://en.wikipedia.org/wiki/File:Yang\\_and\\_Schank\\_2006\\_converging\\_diverging\\_cycles2.jpg](https://en.wikipedia.org/wiki/File:Yang_and_Schank_2006_converging_diverging_cycles2.jpg)

# Most take a similar approach

- Inherently unbalanced data (seizures are rare compared to interictal EEG)
- Non-continuous datasets (i.e., inter-ictal and pre-ictal chunks) can make task easier than reality
- Scoring predictions is challenging (prediction window / time to seizure onset)
- Suitable baseline performance metric (random prediction: diurnal?)
- Inter-person variance can be large (electrode placement, cycles)

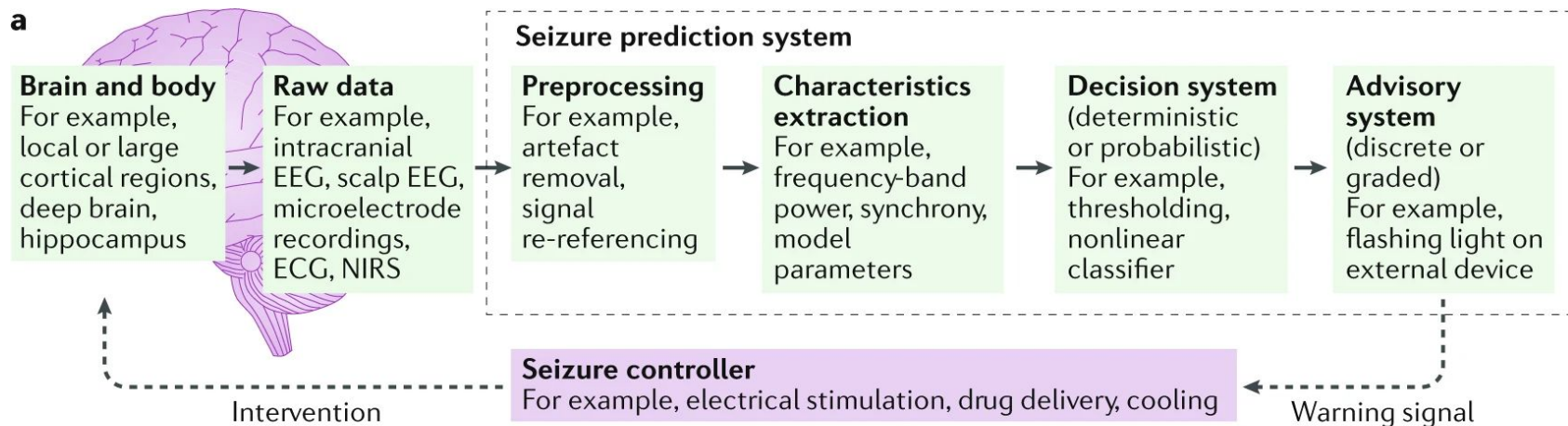

# American Epilepsy Society Seizure Prediction Challenge

- Winning entry: well-crafted features for GLMs (averages with RF)
- General approach: bunch of features into large ensemble models
- 2014 (still relatively early days for CNNs being used outside of images)

	Dog_1	Dog_2	Dog_3	Dog_4	Dog_5	Patien	Patien	all
SVC_ica_psd_logfBB_AND_ica_xcorr-tpeak	0.8175	0.9253	0.8129	0.7371	0.8617	0.8346	0.7526	0.8493
SVC_ica_ilingam-causalindex_AND_ica_PSDlogfcorrcoef	0.8125	0.9904	0.7356	0.6645	0.8540	0.9355	0.4759	0.8362
SVC_ica_PSDlogfcorrcoef_AND_ica_pwling5	0.8101	0.8916	0.7657	0.6663	0.9073	0.8236	0.5182	0.8280
SVC_ica_cov_AND_ica_lmom-3	0.8081	0.9383	0.8109	0.6689	0.9018	0.7532	0.6210	0.8458
SVC_ica_corrcoefeig_AND_ica_PSDlogfcorrcoef	0.8071	0.9858	0.7791	0.6792	0.8970	0.9208	0.4920	0.8456
SVC_ica_psd_logfBB_AND_ica_PSDlogfcorrcoef	0.8063	0.9856	0.8033	0.7442	0.8477	0.9002	0.7618	0.8618
SVC_ica_ilingam-causalorder_AND_ica_psd_logfBB	0.8059	0.9685	0.8166	0.7623	0.8398	0.8660	0.8117	0.8596
SVC_ica_ilingam-causalindex_AND_ica_psd_logfBB	0.8049	0.9783	0.8133	0.7610	0.8429	0.8653	0.8020	0.8619
SVC_ica_lmom-3_AND_ica_PSDlogfcorrcoef	0.8011	0.9816	0.7282	0.6717	0.8756	0.9547	0.4971	0.8400
SVC_ica_lmom-2_AND_ica_psd_logfBB	0.8008	0.9755	0.8358	0.7575	0.8591	0.8486	0.8169	0.8643
SVC_ica_ampcorrcoef-alpha-eig_AND_ica_pib_ratioBB	0.8004	0.9546	0.8612	0.7408	0.8666	0.8825	0.7204	0.8584
SVC_ica_pib_ratioBB_AND_ica_pwling5	0.7991	0.8737	0.8724	0.7281	0.8607	0.8163	0.5582	0.8353
SVC_ica_gcaus_AND_ica_pib_ratioBB	0.7973	0.9770	0.8548	0.7212	0.8296	0.8927	0.7014	0.8566
SVC_ica_lmom-4_AND_ica_psd_logfBB	0.7962	0.9711	0.8367	0.7613	0.8446	0.8588	0.8186	0.8613
SVC_ica_ampcorrcoef-high_gamma_AND_ica_phase-beta-sync	0.7921	0.9450	0.7474	0.6594	0.9699	0.9032	0.5327	0.8439
SVC_ica_ampcorrcoef-low_gamma_AND_ica_psd_logfBB	0.7899	0.9449	0.8367	0.7463	0.8714	0.8434	0.7935	0.8506
SVC_ica_ampcorrcoef-alpha-eig_AND_ica_phase-beta-sync	0.7889	0.9789	0.7460	0.7239	0.9605	0.9157	0.5430	0.8559
SVC_ica_ampcorrcoef-high_gamma-eig_AND_ica_corrcoef	0.7873	0.9320	0.8261	0.6221	0.9360	0.7966	0.6627	0.8563
SVC_ica_PSDlogfcorrcoef_AND_ica_xcorr-ypeak	0.7869	0.9826	0.7565	0.6327	0.9433	0.8982	0.7139	0.8641
SVC_ica_psd_logf_AND_ica_PSDlogfcorrcoef	0.7866	0.9816	0.8291	0.7369	0.8993	0.8998	0.7395	0.8725
SVC_ica_phase-beta-sync_AND_ica_pib	0.7770	0.9806	0.8304	0.6789	0.9556	0.9166	0.6674	0.8626
SVC_ica_ampcorrcoef-beta AND_ica_phase-beta-sync	0.7737	0.9440	0.7624	0.7355	0.9632	0.8947	0.5755	

# Modern approaches

- Deep neural networks (static or dynamic input)
- Learnt representations of EEGs (wavelet, kernels, attention, embeddings)
- Still suffer from inter-person variance (and relatively rarity of seizures): individualised tuning
- Specificity still challenging

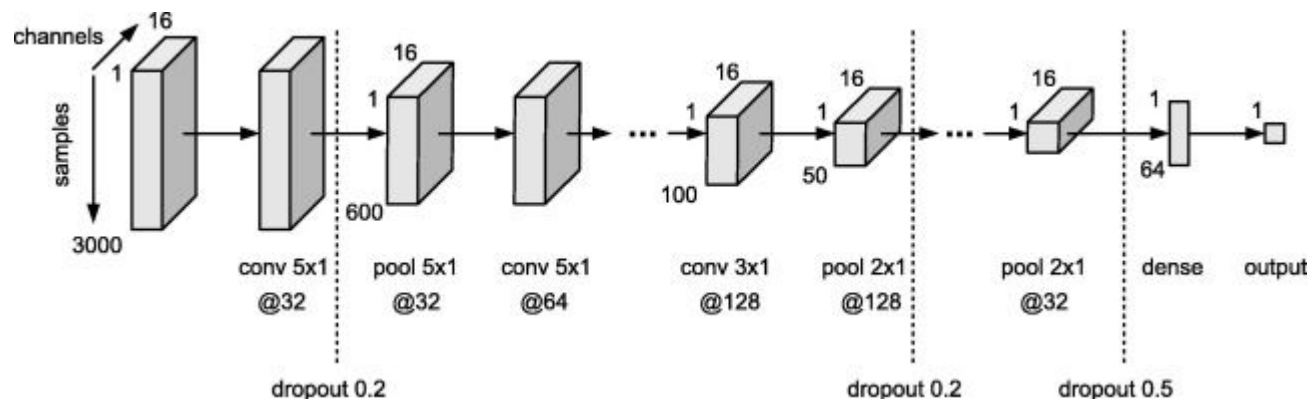
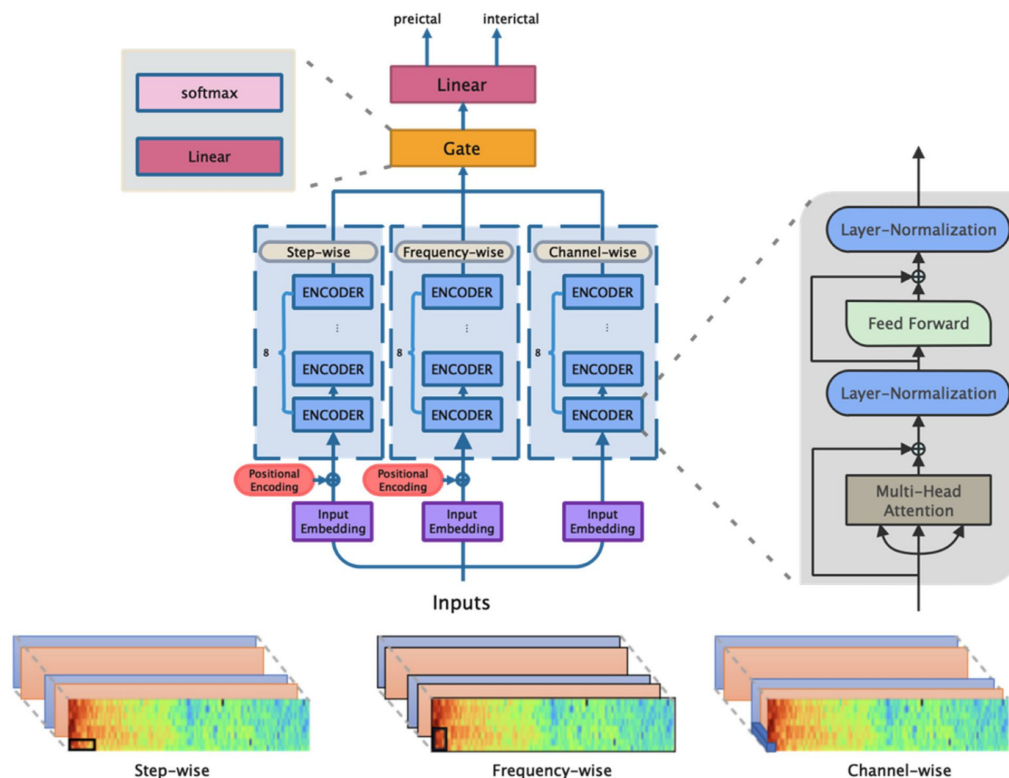

# High variance clinical trials: implementation science is key

- 3-100% accuracy across  $\geq 3$  seizures across individuals
- Seizures are non-random (short and long-term temporal dependence)
- Diving into why they don't haven't worked:
  - Individual seizure frequency
  - long-term temporal variations in seizure frequency
  - multimodal distributions of seizure duration and inter-ictal intervals

## Lessons learnt:

- EEGs give poor mechanistic insight
- Emerging ideas about how seizures work: excitation/inhibition imbalance vs aberrant behaviour emerging from network parameters
- Implementation science is often more important than underlying ML

# Learning Overview

- Types of medical sensor data
- Time-domain approaches: detrending/regression models
- Alternative decomposition: frequency/time-frequency
- State-space approaches: hidden markov models
- Handling data from multiple sensors
- General purpose Bayesian approaches: Gaussian Processes
- Cough-detection example
- Segmentation of heartbeats example
- Seizure prediction example